

Thank you for purchasing an Acoustic Research product. We pride ourselves on the quality and reliability of all our electronic products. For service or repairing, please contact the authorized local distributor(s).  
Latest software update and documentations are available at  
[WWW.ACOUSTIC-RESEARCH.COM](http://WWW.ACOUSTIC-RESEARCH.COM)

**M2**

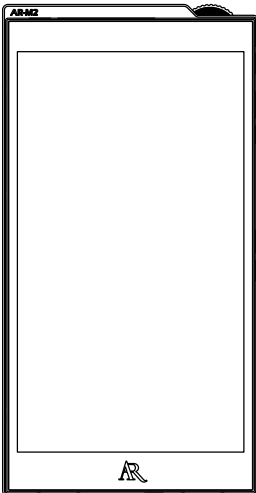

It is important to read this user manual prior to using your new product for the first time.

# Important information

## Important battery information

Warning: Your product contains a battery and charging system which is designed to work in temperatures that do not exceed 50°C (122°F). Leaving this product in a closed automobile or the trunk of an automobile where temperatures may exceed 50°C may result in permanent battery damage, fire, or explosion. Please remove your product from the automobile when you exit, do not place your product in the trunk of your automobile, and do not leave your product in any location where temperatures may exceed 50°C.

## Ecology

Your product must be disposed of properly according to local laws and regulations. Because this product contains a battery, the product must be disposed of separately from the household waste.

## Precautions for the unit

- Do not use the unit immediately after transportation from a cold place to a warm place; condensation problems may result.
- Do not store the unit near fire, places with high temperature or in direct sunlight. Exposure to direct sunlight or extreme heat (such as inside a parked car) may cause damage or malfunction.
- Do not expose to rain or moisture.
- Clean the unit with a soft cloth or a damp chamois leather. Never use solvents.
- The unit must only be opened by qualified personnel.

## Headset safety

To use a headset safely, please keep the following in mind:

- Do not play your headset at an excessive volume. Hearing experts advise against continuous extended play.
- If you experience ringing in your ears, turn down the volume or stop using the headset.
- Do not use a headset while driving a motorized vehicle or riding a bike. It may cause a traffic hazard and is illegal in many areas.
- Even if your headset is an open-air type designed to let you hear outside sounds, don't turn up the volume so high that can't hear sounds around you.

## Limitation of liability

(a) TO THE MAXIMUM EXTENT PERMITTED BY APPLICABLE LAW, IN NO EVENT SHALL VOXX, OR ITS DEALERS BE LIABLE FOR ANY SPECIAL, INCIDENTAL, INDIRECT, OR CONSEQUENTIAL DAMAGES WHATSOEVER (INCLUDING, WITHOUT LIMITATION, DAMAGES FOR LOSS OF PROFITS, BUSINESS INTERRUPTION, CORRUPTION OF FILES, LOSS OF BUSINESS INFORMATION, OR ANY OTHER PECUNIARY LOSS) REGARDLESS OF CAUSE OR FORM OF ACTION, INCLUDING CONTRACT, TORT, OR NEGLIGENCE, ARISING OUT OF YOUR USE OF OR INABILITY TO USE THE PROGRAM, EVEN IF VOXX HAS BEEN ADVISED OF THE POSSIBILITY OF SUCH DAMAGES. BECAUSE SOME STATES AND JURISDICTIONS DO NOT ALLOW THE EXCLUSION OR LIMITATION OF LIABILITY OF CONSEQUENTIAL OR INCIDENTAL DAMAGES, THE ABOVE LIMITATION MAY NOT APPLY TO YOU.

(b) YOU ASSUME RESPONSIBILITY FOR THE SELECTION OF THE APPROPRIATE PROGRAM TO ACHIEVE YOUR INTENDED RESULTS, AND FOR THE INSTALLATION, USE, AND RESULTS OBTAINED.

# Contents

## Important information

Important battery information .....	1
Ecology .....	1
Precautions for the unit .....	1
Headset safety .....	1
Limitation of liability .....	1

## Before you begin

Copyright warning.....	4
Back up your data .....	4
Unpacking your Player .....	4
Computer system requirements.....	4
Charging the Player .....	5

## General controls

Switching the Player on and off.....	6
Switching on and off the display and screen lock.....	6
Resetting the Player .....	6
Headphones volume adjustment .....	6
Connecting with headphones or earphones.....	6
Connecting with a speaker.....	6

## Managing files on your Acoustic Research Player

Connecting to the computer.....	7
Deleting files from the Player .....	9

## Expanding the capacity of the Player

Inserting microSD card .....	9
Removing microSD card .....	9

## Menus and navigations

Home screen .....	10
Application menu .....	10

**Using the AR Music Player application**

Accessing the AR Music Player ..... 11

The interface ..... 11

Selecting an audio file for playback..... 12

Showing the option menu (Play/Delete/Add to playlist/Details) ..... 12

Playlists..... 12

Sound effects ..... 13

Settings ..... 13

**Additional information**

Frequently asked questions ..... 14

Installing third party Android application package (APK) ..... 15

Visiting Acoustic Research website ..... 15

Technical specification ..... 15

Specifications..... 15

# Before you begin

## **Dear Acoustic Research Customer,**

Thank you for purchasing the Player. This product will play FLAC, Apple Lossless, WAV, AIFF, Monkey's Audio (APE) and DSD contents.

## Copyright warning

This Player is for your personal use only. Unauthorized recording or duplication of copyrighted material may infringe upon the rights of third parties and may be contrary to copyright laws.

## Back up your data

As with any portable Player, you must back up the drive regularly. The manufacturer is not responsible for lost data.

## Unpacking your Player

All of the items listed below should have been packed in the box with your Player.

- Acoustic Research M2
- Quick Start Guide
- AC/DC power adapter with interchangeable plugs
- USB connector cable

## Computer system requirements

PC requirements:

- Windows® 7 / Windows® 8
- Windows Media Player 10 or higher
- USB port (2.0 recommended)

Mac requirements:

- Mac OS X (10.5 or above)
- Google Android File Transfer
- USB port (2.0 recommended)

## Charging the Player

Connect the USB port of the included AC/DC power adapter to the Player. Plug the other end of the adapter to any standard 100-240V AC wall outlet. Charging should be started automatically. Make sure you have charged the Player for at least 6 hours before using for the first time.

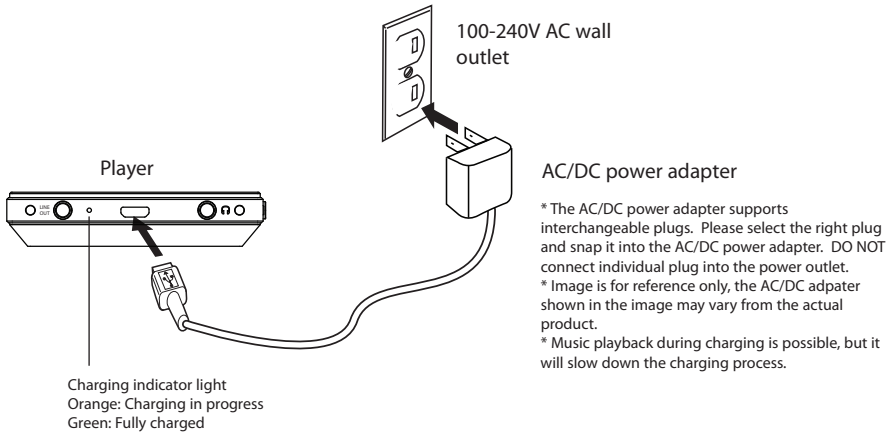

Alternatively, you can connect the Player to the computer USB port through the included USB cable. Make sure the USB port of your computer has 500 mA or higher current supply for battery charging.

Refer to the battery level icon  on the display to check the battery level. Recharge the Player when the battery level is low. Some computers may not stop the charging when they have entered the power saving mode.

## General controls

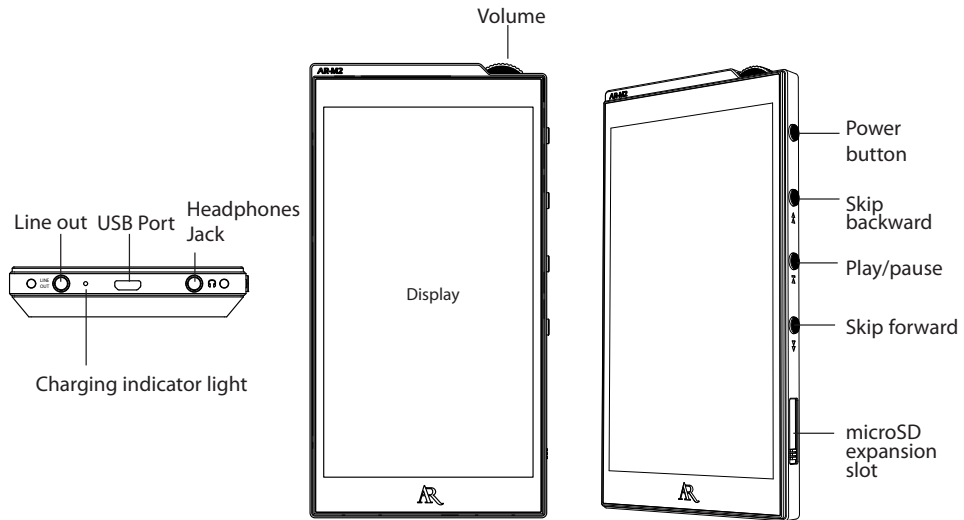

### Switching the Player on and off

- To switch on, press and hold the **Power** button for 3 seconds.
- To switch off, press and hold the **Power** button for 3 seconds and then tap on **Power Off** on the screen.

### Switching on and off the display and screen lock

- To switch on the display and unlock the screen, press the **Power** button and then swipe the lock icon towards any sides of the screen.
- To switch off the display and lock the screen, press the **Power** button. The display will also switch off automatically after a period of inactivity (default: 1 minute).

### Resetting the Player

In case the Player is not responding, press and hold the **Power** button for 10 seconds to reset it.

### Headphones volume adjustment

Make sure that the headphones are connected to the headphones jack. Rotate the volume knob clockwise to reduce the volume or counterclockwise to increase it.

### Connecting with headphones or earphones

Connect your headphones or earphones to the **Headphones** jack for private listening. To protect your hearing, reduce the volume to the minimum before connecting your headphones or earphones.

### Connecting with a speaker

Connect the Player with an external powered speaker system by inserting an audio cable (not provided) to the **LINE OUT** jack. The output level from the line out jack is fixed and cannot be controlled by the volume knob.

**IMPORTANT:** When both line out and headphones jacks are connected, music playback will be disabled. Only one of the connections can be used at a time.



# Managing files on your Acoustic Research Player

Before you begin using your Acoustic Research Player, you'll want to copy your audio files to the Player. You can drag and drop files using Windows Explorer (PC) or Android File Transfer (Mac) to transfer content.

## Connecting to the computer

- Switch on the Player and connect the it to your computer with the USB connector cable provided.
- For PC users: The Player will be connected in MTP (Media Transfer Protocol) mode. It will appear as a media device on your computer for file transfer.
- For Mac users: You can download and install the free program "Android File Transfer" on your computer in order to transfer files. Visit [www.android.com/filetransfer/](http://www.android.com/filetransfer/) to download the software.
- See the chapter "Managing files on your Acoustic Research Player" for details regarding transferring files to the Player

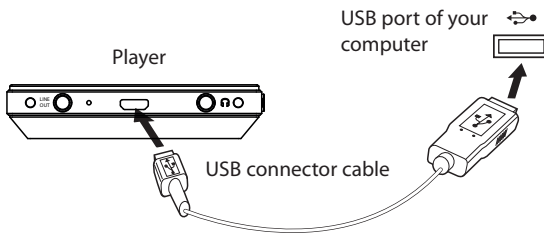

- It may take several seconds for the Player to be detected. Refresh your computer screen to make sure the Player has been detected.
- The Player is capable of transferring files using USB 2.0. If a USB 2.0 port is available on your computer, use it to connect to your Player. The Player is still backward compatible with the older USB 1.1 ports; however, you will not be able to take full advantage of the potential speed increase.
- **IMPORTANT:** Do not disconnect the USB connection from either the PC or the Player during the transfer of file or software installation.





## Using Windows Explorer (PC)

1. Make sure the Player is connected to your computer.
2. Open **Windows Explorer**, select **Computer**, open **ARM2** under **Portable Devices**.
3. Open the desired storage media **Internal SD** card or **SD card** (if a microSD card is inserted).
4. Drag and drop audio files (or folders containing audio files) from your computer to the desired locations on the Player. Audio files are automatically organized under different views according to embedded music tags.
5. After the transfer, disconnect the Player from the computer.

## Using Android File Transfer (Mac)

1. Download **Android File Transfer** (from [www.android.com/filetransfer/](http://www.android.com/filetransfer/)) and install it in your computer.
2. Connect the Player to the computer.
3. The **Android File Transfer** software should be launched automatically when the Player is detected by the computer. If not, open it manually.
4. Select the desired storage media by clicking on the tab **Internal SD card** or **SD card** (if a microSD card is inserted).
5. Drag-and-drop audio files (or folders containing audio files) from your computer to the desired locations on the Player. Audio files are automatically organized under different views according to embedded music tags.
6. After the transfer, disconnect the Player from the computer.

## Deleting files from the Player

You may delete any files transferred to the Player.

1. Connect the Player to your computer.
2. Open the Player in Windows Explorer (PC) or Android File Transfer (Mac) and then navigate to the folder containing the files.
3. Select the files you want to remove and then press the Delete key on the keyboard of your computer.

**IMPORTANT:** Do not disconnect the USB connection during file transfer. Doing so may corrupt system files or the files being transferred.



Alternatively, you can also delete any files from the Player without connecting to your computer. To do so, just tap and hold on an item to be deleted and then select **Delete** from the option menu. For more details, see the section "Showing the option menu" under the chapter "Using the AR Music Player app".

## Expanding the capacity of the Player

The storage capacity of the Player can be expanded by inserting a microSD card into the Player. The Player supports a microSD card with a capacity up to 128 GB.

### Inserting microSD card

1. Slide open the cover of the microSD expansion slot.
2. Insert a microSD card into the card slot. The card is properly inserted when you hear a click sound.
3. Slide the cover to close the microSD expansion slot.

### Removing microSD card

1. Swipe down from the top of the screen to open the notification bar.
2. Tap on the option **SD card connected - Touch to unmount sdcard**.
3. Slide open the cover of the microSD expansion slot and then push the card into the slot until you hear a click sound.
4. Remove the card when it is ejected and close the expansion slot cover.

# Menus and navigations

## Home screen

The home screen shows after the Player is turned on.

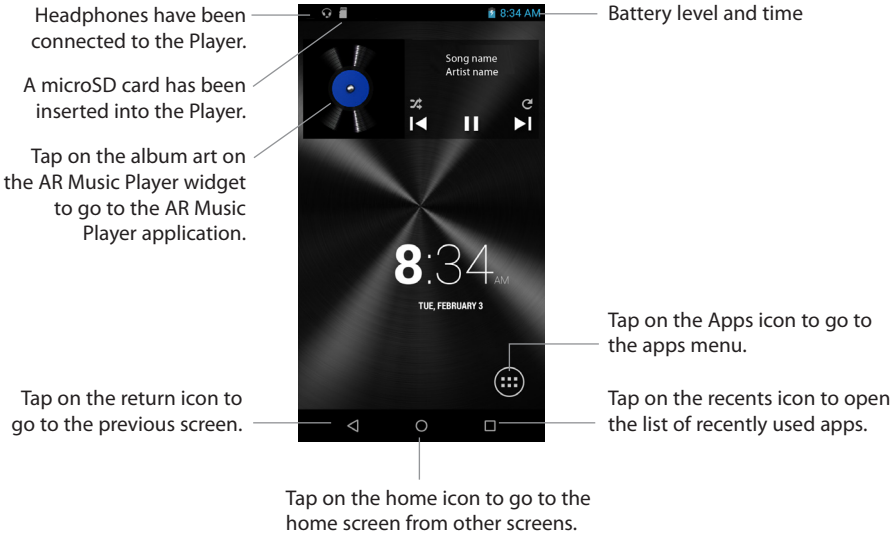

## Application menu

- Tap on the Application icon (⋮) at the lower right corner of the home screen to go to the Application menu.
- The Application menu has been pre-loaded with a number of applications that come with the device software version 1.0. Tap on an icon to start using an application.
- The **AR Music Player** application is especially made for music playback from the Player. Tap on the **AR Music Player** icon to start playing music.

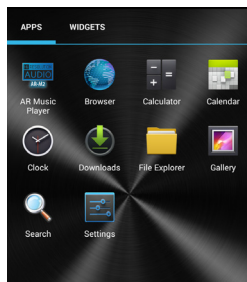

# Using the AR Music Player application

## Accessing the AR Music Player

Tap on the **AR Music Player** icon in the Apps menu to start using the music player.

## The interface

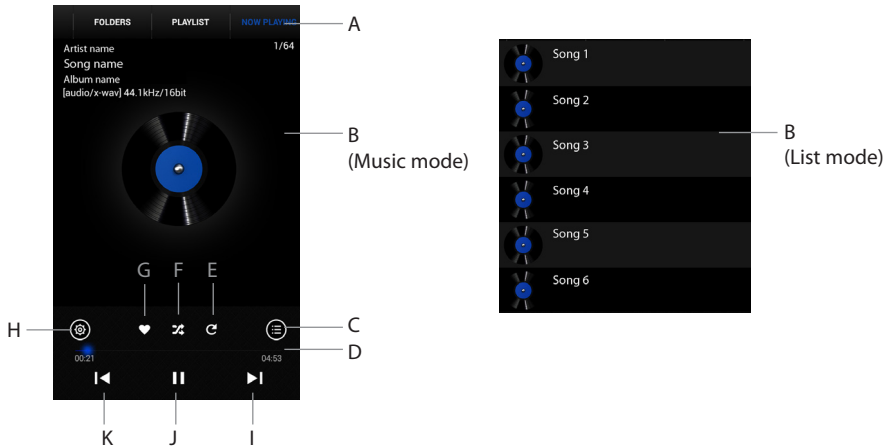

### A. Top bar

- Audio files are automatically organized under different views. Swipe the top bar and then tap on a desired view option. The sorted list of files will show in the main display area for further selections.
- The view options include:
  - All** - shows all audio files
  - Albums** - audio files are sorted according to albums
  - Artists** - audio files are sorted according to artists
  - Genres** - audio files are sorted according to genres
  - Folders** - audio files are sorted according to their stored locations
  - Playlist** - audio files are sorted according to playlists
  - Now playing** - shows the audio file currently being played

### B. Main display area

- Shows album art, song title, song information (in Music mode) or list of files (in List mode).

### C. List or Music mode

- Tap on this icon to switch between List and Music modes. In List mode, the main display area shows the list of files according to the view option you have selected at the top bar. In Music mode, the main display area shows the album art, song title and information of the current audio file.

### D. Progress bar

- It shows the playback progress. Tap on the bar to jump to the corresponding position within an audio file and start playback from that position.

### E. Repeat mode

- Tap on this icon once to activate repeat playback of all audio files, tap again to activate repeat playback of the current audio file, tap the third time to deactivate the repeat playback mode.

F. **Shuffle mode**

- Tap on this icon to activate or deactivate the shuffle playback mode.

G. **Favourite**

- Tap on this icon to add audio files to the favourites playlist.

H. **Settings**

- Tap on this icon to further select the Settings and Sound Effects menus

I. **Skip forward**

- Tap on this icon to skip to the next file.

J. **Start or pause**

- Tap on this icon to start or pause the playback.

K. **Skip backward**

- Tap on this icon to skip to the beginning of the current audio file. Tap on this icon within the first 4 seconds of the current audio file to skip to the previous audio file.

## Selecting an audio file for playback

1. Swipe the top bar and then tap on a file viewing option.
2. Select an audio file in the main display area.
3. Tap on the selected audio file to start the playback.

## Showing the option menu (Play/Delete/Add to playlist/Details)

1. In any lists of files, tap and hold on an item to show the option menu.
2. You may select to play the item, add it to the playlist, show its details or delete it.  
Note that some options may not be available at all times depending on the nature of the item you have tapped on.

## Playlists

### Default playlists

1. Swipe the top bar and then tap on **Playlist** to access the playlists.
  2. Select a playlist in the main display area.
- There are 4 default playlists:

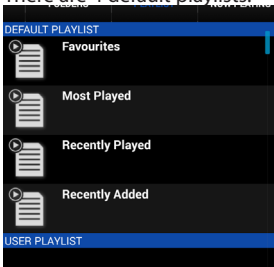

- Favourites** - shows the list of audio files that you have set as favourite by tapping on the Favourite icon.
- Most Played** - shows the list of audio files that you have most frequently listened to.
- Recently Played** - shows the list of audio files that you have recently played.
- Recently Added** - shows the list of audio files that you have recently added in the Player.

3. Tap on an audio file in the list to start the playback.

### Creating your own playlist

1. Swipe the top bar and then tap on a file viewing option.
2. In the main display area, tap and hold on an audio file, an album, an artist or a genre.
2. Select **Add to playlist** from the option menu.
3. To add the item to an existing playlist, tap on the name of the existing playlist.
- To add the item to a new playlist, tap on **New**. Then create a name for the new playlist and then tap on **Save**.

### Editing your own playlists

1. Tap and hold on the name of your playlist to be edited.
2. From the option menu, select **Rename** to create a new name for the playlist, or select **Delete** to erase the playlist.

## Sound effects

Tap on the Settings icon and then select **Sound Effects** to access the Sound Effects menu.

Select a preset sound effect. Tap **User** to customize your own sound effect preferences.

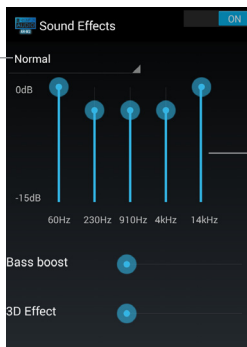

Switch on or off the sound effects

Slide the vertical bars to adjust the equalizer.

Adjust the bass boost level

Adjust the 3D effect level

## Settings

Tap on the Settings icon and then select **Settings** to access the Settings menu. You can check the current software version and activate/deactivate the debug mode for software developers.

## Additional information

### Frequently asked questions

#### **Player repeats same tracks or all tracks.**

- Repeat play is turned on.

#### **Adjusting volume knob does not change the volume level.**

- The volume knob only controls the output level of the headphones. The line output will only output at a fixed volume level. If you are using headphones, please connect them to the headphone jack.

#### **Audio distorted at high volume.**

- The power output of M2 may be higher than what the earphones/headphones can handle. Please lower the volume.

#### **The audio tracks on my Player keep skipping or popping.**

- You'll need to rip the audio track again – make sure you close all other applications on your computer when you record.
- Try ripping with the Error Correction setting turned on.
- For accurate CD ripping, CD rippers with AccurateRIP is recommended. For more information, please visit <http://www.accuraterip.com/>.

#### **The Player cannot be turned on.**

- Battery is empty, please recharge.
- Please go to [www.acoustic-research.com](http://www.acoustic-research.com) for more details.

#### **Noise is heard during volume adjustment.**

- The Player adopts a classical potentiometer for better acoustic linearity. There may be audible noise during adjustment.

#### **Pop noise occurs between music tracks or during power on/off.**

- Pop noise may occur in case the current playlist contains tracks of mixed sample rates.
- Pop noise may occur when the amplifier circuit switch on for music playback or switch off after a period of idling.

#### **The Player does not allow me to start any music playback.**

- Either the headphone or line out jack must be connected to allow music playback.
- Make sure both headphone and line out jacks are not connected at the same time. Otherwise, music playback will be disabled.

#### **The File Explorer application does not show all music files.**

- This is a known limitation of the File Explorer application. Please browse the music files with the AR Music Player application.

#### **There is no Google Play Store on the Player.**

- The Player is a device customized for high precision music playback with proprietary technologies. Google Play Services are not supported.
- Third party app store may be installed for easier installation of third party applications.

## Installing third party Android application package (APK)

- By default, the Player does not allow the installation of third party applications.
- By checking the "Unknown sources" option under Settings > Security, the Player will allow the installation of third party Android application package (APK).
- Compatibility of third party applications on the Player is not guaranteed. Please seek advice from the application developers regarding any compatibility issue.
- Third party applications may interfere the normal functions of the Player. If there is any unexpected issue, please uninstall the third party applications or perform a factory data reset.

### **IMPORTANT:**

Do not load third party firmware into the Player.

- The player may not function properly after third party firmware is loaded.
- Loading third party firmware will void the warranty.



## Visiting Acoustic Research website

Please visit [www.acoustic-research.com](http://www.acoustic-research.com) for:

- Latest software and firmware
- User manual
- Frequently asked questions (FAQ)
- Customer service and technical support information

## Technical specification

Power source:

- Built-in rechargeable lithium-polymer battery 3.7V
- USB power (from a computer via the supplied USB connector cable)
- AC/DC power (5V 2A)

## Specifications

### **Hardware**

- Dimensions: 136.5 mm H, 71.1 mm W, 15 mm D
- Unit Weight: 245 g
- 3.5 mm stereo headphones jack
- 3.5 mm stereo line out jack
- Micro USB Connection jack
- Battery: Internal rechargeable lithium battery
- Wireless connectivity: Wireless LAN 802.11 b/g/n (2.4GHz)

### **USB Drive**

- Capacity: About 55 GB usable (Some memory spaces have been reserved for operating system, applications and system recovery)
- Connection: USB 2.0, Hi-speed capable
- Memory Expansion: MicroSD card slot (supports micro SD/SDHC/SDXC memory card up to 128 GB)



Illustrations contained within this publication are for representation only and subject to change.

The descriptions and characteristics given in this document are given as a general indication and not as a guarantee. In order to provide the highest quality product possible, we reserve the right to make any improvement or modification without prior notice.



For Customer Service  
Visit Our Website At  
**[www.acoustic-research.com](http://www.acoustic-research.com)**  
Product Information, Photos,  
FAQ's, Owner's Manuals

©2015 VOXX Accessories Corporation  
A wholly-owned subsidiary of VOXX International  
Corporation  
Indianapolis, IN  
Trademark(s) ® Registered

v1.0 (1.0.1.0) (EN)