

CXC

COMPACT DISC TRANSPORT



Contents

IMPORTANT SAFETY INSTRUCTIONS	3
LIMITED WARRANTY	5
FRONT PANEL CONTROLS	6
DISPLAY FUNCTIONS	6
REAR PANEL CONTROLS	7
REMOTE CONTROL	8
OPERATING INSTRUCTIONS	9
CUSTOM INSTALLATION (C.I.) USE	10
TECHNICAL SPECIFICATIONS	10
TROUBLESHOOTING	10

This guide is designed to make installing and using this product as easy as possible. Information in this document has been carefully checked for accuracy at the time of printing; however, Cambridge Audio's policy is one of continuous improvement, therefore design and specifications are subject to change without prior notice.

This document contains proprietary information protected by copyright. All rights are reserved. No part of this manual may be reproduced by any mechanical, electronic or other means, in any form, without prior written permission of the manufacturer. All trademarks and registered trademarks are the property of their respective owners.

© Copyright Cambridge Audio Ltd 2019.

Make sure you register your CA product:
WWW.CAMBRIDGEAUDIO.COM/REGISTER

For upcoming news on future products, software updates and exclusive offers.

Support

FAQS AND SUPPORT

Please visit <https://techsupport.cambridgeaudio.com>

GET IN CONTACT WITH OUR DEDICATED TECHNICAL SUPPORT TEAM:

support@cambridgeaudio.com

UK: +44 20 7551 5422

US: +1 877 357-8204

HK: +852 2499 6018

Important safety instructions

For your own safety please read the following important safety instructions carefully before attempting to connect this unit to the mains power supply. They will also enable you to get the best performance from and prolong the life of the unit:

1. Read these instructions.
2. Keep these instructions.
3. Heed all warnings.
4. Follow all instructions.
5. Do not use this apparatus near water.
6. Clean only with a dry cloth.
7. Do not block any ventilation openings. Install in accordance with the manufacturer's instructions.
8. Do not install near any heat sources such as radiators, heat registers, stoves, or other apparatus (including amplifiers) that produce heat.
9. Do not defeat the safety purpose of the polarized or grounding-type plug. A polarized plug has two blades with one wider than the other. A grounding-type plug has two blades and a third grounding prong. The wide blade or the third prong are provided for your safety. If the provided plug does not fit into your outlet, consult an electrician for replacement of the obsolete outlet.
10. Protect the power cord from being walked on or pinched, particularly at plugs, convenience receptacles and the point where they exit from the apparatus.
11. Only use attachments/accessories specified by the manufacturer.
12. Use with only the cart, stand, tripod, bracket, or table specified by the manufacturer, or sold with the apparatus. When a cart is used, use caution when moving the cart/apparatus combination to avoid injury from tip-over. 
13. Unplug this apparatus during lightning storms or when unused for long periods of time.
14. Refer all servicing to qualified service personnel. Servicing is required when the apparatus has been damaged in any way, such as the power-supply cord or plug having been damaged, liquid has been spilled or objects have fallen into the apparatus, the apparatus has been exposed to rain or moisture, does not operate normally, or has been dropped.

WARNING:

- Do not place the unit in an enclosed space; if you wish to place the unit on a shelf, use the top shelf to allow maximum ventilation. Do not put any objects on top of this unit. Do not situate it on a rug or other soft surface and do not obstruct any air inlets or outlet grilles. Do not cover the ventilation grilles with items such as newspapers, tablecloths, curtains, etc.
- To reduce the risk of fire or electric shock, do not expose this apparatus to rain or moisture. This unit must not be used near water or exposed to dripping or splashing water or other liquids. No objects filled with liquid, such as vases, shall be placed on the unit.
- Danger of explosion if battery is incorrectly replaced. Replace only with the same or equivalent type.
- The battery (battery pack or batteries installed) shall not be exposed to excessive heat such as sunshine, fire or the like.
- The unit must be installed in a manner that makes disconnection of the mains plug from the mains socket outlet (or appliance connector from the rear of the unit) possible. Where the mains plug is used as the disconnect device, the disconnect device shall remain readily operable.
- Please refer to the information on the exterior rear panel for electrical and safety information before installing or operating the apparatus.
- Only use the mains cord supplied with this unit.

Use of the apparatus in tropical climates - The equipment shall be used at a maximum 45 degree C ambient temperature.

The unit is of Class 1 construction and must be connected to a mains socket outlet with a protective earthing connection.



The lightning flash with the arrowhead symbol within an equilateral triangle is intended to alert the user to the presence of un-insulated 'dangerous voltage' within the product's enclosure that may be of sufficient magnitude to constitute a risk of electric shock to persons.

Warning: To reduce the risk of electric shock, do not remove cover (or back) as there are no user-serviceable parts inside. Refer servicing to qualified personnel.

The exclamation point within an equilateral triangle is intended to alert the user to the presence of important operating and maintenance instructions in the service literature relevant to this appliance.

VENTILATION

Important! The unit will become hot when in use. Do not stack multiple units on top of each other.

Ensure that small objects do not fall through any ventilation grille. If this happens, switch off immediately, disconnect from the mains supply and contact your dealer for advice.

POSITIONING

Choose the installation location carefully. Avoid placing it in direct sunlight or close to a source of heat. No naked flame sources, such as lighted candles, should be placed on the unit. Also avoid locations subject to vibration and excessive dust, cold or moisture. The unit can be used in a moderate climate.

This unit must be installed on a sturdy, level surface. Do not place in a sealed area such as a bookcase or in a cabinet. Do not place the unit on an unstable surface or shelf. The unit may fall, causing serious injury to a child or adult as well as serious damage to the product. Do not place other equipment on top of the unit.

Due to stray magnetic fields, turntables or CRT TVs should not be located nearby due to possible interference.

Electronic audio components have a running in period of around a week (if used several hours per day). This will allow the new components to settle down and the sonic properties will improve over this time.

POWER SOURCES

The unit should be operated only from the type of power source indicated on the marking label. If you are not sure of the type of power-supply to your home, consult your product dealer or local power company.

If you do not intend to use this unit for a long period of time, unplug it from the mains socket.

OVERLOADING

Do not overload wall outlets or extension cords as this can result in a risk of fire or electric shock. Overloaded AC outlets, extension cords, frayed power cords, damaged or cracked wire insulation and broken plugs are dangerous. They may result in a shock or fire hazard.

Be sure to insert each power cord securely. To prevent hum and noise, do not bundle the interconnect leads with the power cord or speaker leads.

CLEANING

To clean the unit, wipe its case with a dry, lint-free cloth. Do not use any cleaning fluids containing alcohol, ammonia or abrasives. Do not spray an aerosol at or near the unit.

BATTERY DISPOSAL

Batteries may contain substances harmful to the environment. Please dispose of any discharged batteries with due consideration and in accordance with local environmental/electronic recycling guidelines.

SERVICING

These units are not user serviceable. Never attempt to repair, disassemble or reconstruct the unit if there seems to be a problem. A serious electric shock could result if this precautionary measure is ignored. In the event of a problem or failure, please contact your dealer.

**WEEE SYMBOL**

The crossed-out wheeled bin is the European Union symbol for indicating separate collection for electrical and electronic equipment. This product contains electrical and electronic equipment which should be reused, recycled or recovered and should not be disposed of with unsorted regular waste. Please return the unit or contact the authorised dealer from whom you purchased this product for more information.

**CE MARK**

This product complies with European Low Voltage (2014/35/EU), Electromagnetic Compatibility (2014/30/EU) and Environmentally-friendly design of Energy-related Products (2009/125/EC) Directives when used and installed according to this instruction manual. For continued compliance only Cambridge Audio accessories should be used with this product and servicing must be referred to qualified service personnel.

**RCM (REGULATORY COMPLIANCE MARK)**

This product meets Australia, New Zealand Safety, EMC and Radio Communications requirements of the ERAC and ACMA.

**CU-TR MARK**

This product meets Russia, Byelorussia and Kazakhstan electronic safety approvals.

FEDERAL COMMUNICATIONS COMMISSION

Supplier's declaration of conformity (SDoC)

Equipment: COMPACT DISC TRANSPORT

Model: CXC

Trademark: Cambridge Audio

This device complies with Part 15 of the FCC Rules. Operation is subject to the following two conditions: (1) this device may not cause harmful interference, and (2) this device must accept any interference received, including interference that may cause undesired operation.

The responsible party in US:

Company name: Audio Partnership LLC

Address:

1913 N Milwaukee Ave. Chicago, IL 60647

Phone: (312) 636-4817

Legal Representative Person:

Gregg Chopper

Signature:

FEDERAL COMMUNICATIONS COMMISSION NOTICE:

This equipment has been tested and found to comply with the limits for a Class B digital device, pursuant to Part 15 of the FCC Rules. These limits are designed to provide reasonable protection against harmful interference in a residential installation.

This equipment generates, uses, and can radiate radio frequency energy, and if not installed and used in accordance with the instructions, may cause harmful interference to radio communications. However, there is no guarantee that interference will not occur in a particular installation.

If this equipment does cause harmful interference to radio or television reception, which can be determined by turning the equipment off and on, the user is encouraged to try and correct the interference by one or more of the following measures:

- Reorient or relocate the receiving antenna.
- Increase the distance between the equipment and the receiver.
- Connect the equipment to an outlet on a circuit different from that to which the receiver is connected.
- Consult the dealer or an experienced radio/TV technician for help.

FCC Caution: Any changes or modifications not expressly approved by the party responsible for compliance could void the user's authority to operate this equipment.

MODIFICATIONS:

The FCC requires the user to be notified that any changes or modifications to this device that are not expressly approved by Cambridge Audio, may void the user's authority to operate the equipment.

PLUG FITTING INSTRUCTIONS (UK ONLY)

The cord supplied with this appliance is factory fitted with a UK mains plug fitted with a 3 amp fuse inside. If it is necessary to change the fuse, it is important that a 3 amp one is used. If the plug needs to be changed because it is not suitable for your socket, or becomes damaged, it should be cut off and an appropriate plug fitted following the wiring instructions below. The plug must then be disposed of safely, as insertion into a mains socket is likely to cause an electrical hazard. Should it be necessary to fit a 3-pin BS mains plug to the power cord the wires should be fitted as shown in this diagram. The colours of the wires in the mains lead of this appliance may not correspond with the coloured markings identifying the terminals in your plug. Connect them as follows:

The wire which is coloured BLUE must be connected to the terminal which is marked with the letter 'N' or coloured BLACK.

The wire which is coloured BROWN must be connected to the terminal which is marked with the letter 'L' or coloured RED.

The wire which is coloured GREEN/YELLOW must be connected to the terminal which is marked with the letter 'E' or coloured GREEN.

If a 13 amp (BS 1363) plug is used, a 3 amp fuse must be fitted, or if any other type of plug is used a 3 amp fuse must be fitted, either in the plug or adaptor, or on the distribution board.

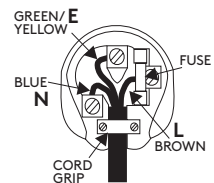

Limited warranty

Cambridge Audio warrants this product to be free from defects in materials and workmanship (subject to the terms set forth below). Cambridge Audio will repair or replace (at Cambridge Audio's option) this product or any defective parts in this product. Warranty periods may vary from country to country. If in doubt consult your dealer and ensure that you retain proof of purchase.

To obtain warranty service, please contact the Cambridge Audio authorised dealer from which you purchased this product. If your dealer is not equipped to perform the repair of your Cambridge Audio product, it can be returned by your dealer to Cambridge Audio or an authorised Cambridge Audio service agent. You will need to ship this product in either its original packaging or packaging affording an equal degree of protection.

Proof of purchase in the form of a bill of sale or receipted invoice, which is evidence that this product is within the warranty period, must be presented to obtain warranty service.

This Warranty is invalid if (a) the factory-applied serial number has been altered or removed from this product or (b) this product was not purchased from a Cambridge Audio authorised dealer. You may call Cambridge Audio or your local country Cambridge Audio distributor to confirm that you have an unaltered serial number and/or you made a purchase from a Cambridge Audio authorised dealer.

This Warranty does not cover cosmetic damage or damage due to acts of God, accident, misuse, abuse, negligence, commercial use, or modification of, or to any part of, the product. This Warranty does not cover damage due to improper operation, maintenance or installation, or attempted repair by anyone other than Cambridge Audio or a Cambridge Audio dealer, or authorised service agent which is authorised to do Cambridge Audio warranty work. Any unauthorised repairs will void this Warranty. This Warranty does not cover products sold AS IS or WITH ALL FAULTS.

REPAIRS OR REPLACEMENTS AS PROVIDED UNDER THIS WARRANTY ARE THE EXCLUSIVE REMEDY OF THE CONSUMER. CAMBRIDGE AUDIO SHALL NOT BE LIABLE FOR ANY INCIDENTAL OR CONSEQUENTIAL DAMAGES FOR BREACH OF ANY EXPRESS OR IMPLIED WARRANTY IN THIS PRODUCT. EXCEPT TO THE EXTENT PROHIBITED BY LAW, THIS WARRANTY IS EXCLUSIVE AND IN LIEU OF ALL OTHER EXPRESS AND IMPLIED WARRANTIES WHATSOEVER INCLUDING, BUT NOT LIMITED TO, THE WARRANTY OF MERCHANTABILITY AND FITNESS FOR A PRACTICAL PURPOSE.

Some countries and US states do not allow the exclusion or limitation of incidental or consequential damages or implied warranties so the above exclusions may not apply to you. This Warranty gives you specific legal rights, and you may have other statutory rights, which vary from state to state or country to country.

For any service, in or out of warranty, please contact your dealer.

Front panel controls

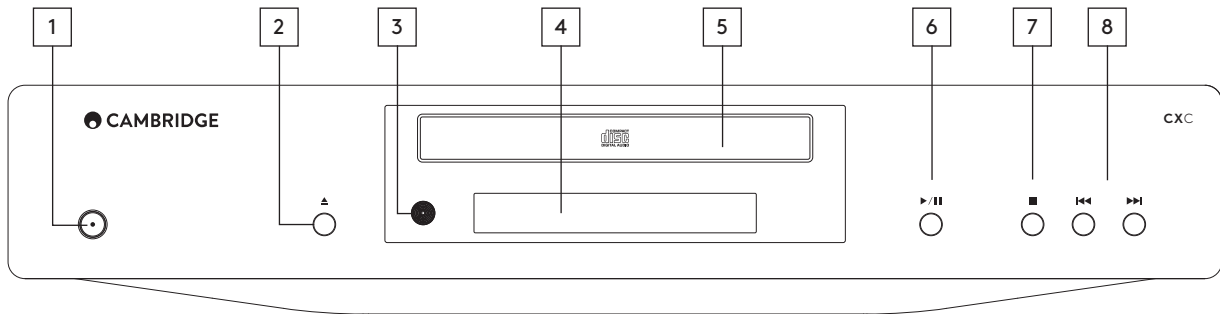

1. STANDBY/ON

Switches the unit between Standby mode (indicated by dim power LED) and On (indicated by bright power LED). Standby mode is a low power mode where the power consumption is less than 0.5 Watts. The unit should be left in Standby mode when not in use.

This product has APD (Auto Power Down) enabled as default. After inactivity of 30 minutes, the product will automatically switch to Standby. See later section for further details.

2. OPEN/CLOSE

Press to Open or Close the disc loading drawer.

Note: Pressing Play when the drawer is open will also close the drawer.

3. INFRARED RECEIVER

Receives IR commands from the CX series remote. A clear unobstructed line of sight between the remote handset and the receiver is required.

4. DISPLAY

The display shows the currently selected source in addition to a variety of CXC operational information.

5. DISC TRAY

Compact Disc tray. Use the Open/Close button to activate.

6. PLAY/PAUSE (▶/||)

Press to Play a loaded disc or to Pause playback if it is underway.

7. STOP ■

Stops CD playback.

8. SKIP/SCAN (◀▶)

Press to skip CD tracks. Pressing and holding the button will scan forwards or backwards through the currently playing CD track. The Skip/Scan buttons are also used for menu navigation.

Display functions

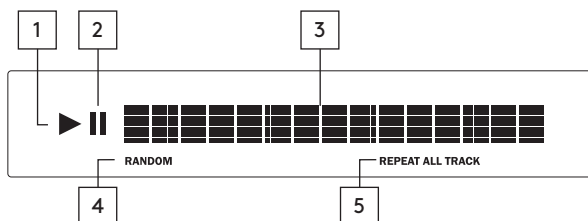

1. PLAY

Illuminated during disc playback.

2. PAUSE

Indicates that disc playback has been paused.

3. DISPLAY

Alpha-numeric characters which display playback information. On inserting a disc, the CD player will take a few seconds to read the Table of Contents (TOC) information from the disc. The display will then show the number of tracks on the CD and the total length of the CD.

If the CD incorporates CD-text, the name of the album will scroll once (the number of tracks remains stationary throughout). Once playback of an individual track begins, the track number, total number of tracks and playtime will be displayed. On a CD containing CD-text, the track name will scroll once.

4. RANDOM

Indicates random playback mode.

5. REPEAT ALL/TRACK

Illuminated when 'Repeat Track' or 'Repeat All' is selected.

Rear panel controls

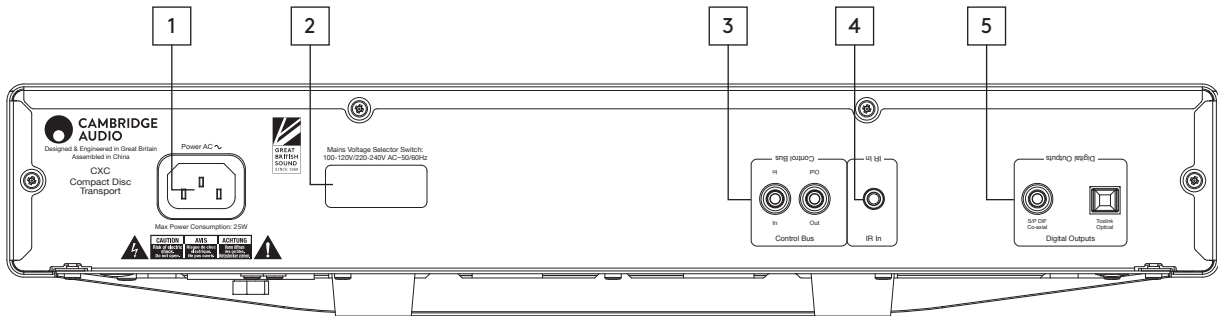

1. AC POWER SOCKET

Once all other connections are made, connect the supplied power cable to the CXC power socket and to an appropriate mains socket. The CXC is now ready for use.

2. MAINS VOLTAGE SELECTOR SWITCH

Switches the CXC mains voltage between 115V and 230V.

Note: For use by Cambridge Audio service personnel only!

3. CONTROL BUS

In – An RCA phono socket that enables un-modulated commands from multi-rooms systems or other components to be received by the CXC.

Out – An RCA phono socket that provides control bus output commands for further downstream units.

4. IR (INFRA RED) IN

A 3.5mm mini-jack socket that enables modulated IR commands from multi-room or IR repeater systems to be received by the CXC.

Note: Commands received by the IR In socket are not looped out of the Control Bus. Refer to the 'Custom Installation' section for more information.

5. DIGITAL INPUTS

The CXC has two digital outputs in total, S/P DIF co-axial and Toslink optical sockets.

Coaxial – To obtain best results, use a high quality 75 ohm digital RCA interconnect cable (not one designed for normal audio use).

Toslink Optical – Use a high quality TOSLINK fibre optic interconnect cable designed specifically for audio use.

Remote control

The CXC is supplied with a remote control handset that duplicates the front panel control functions and is also able to control other CX series products. The supplied AAA batteries must be fitted before the remote control can be used.

The handset buttons function as described in the following paragraphs.

1. BRIGHT

Alters the brightness of the display backlight. There are three levels of brightness: Bright, Dim and Off.

2. STANDBY/ON

Switches the amplifier between On and low power ecofriendly Standby mode.

3. PLAY/4. PAUSE/5. STOP

Press the relevant button to play, pause or stop the CD.

6. OPEN/CLOSE

Opens and closes the disc tray.

7. SCAN

Press and hold to scan within the selected track. Hold down for seven seconds to increase scan speed. Press the right button to fast forward, the left button to rewind.

8. SKIP

Right Skip – Press to skip forward by one track on the CD.

Left Skip – Press to skip backward by one track on the CD.

9. REPEAT/10. RANDOM

Read the 'Operating Instructions' section of this manual for information on the functions of these buttons.

Note: these buttons will function only when the display backlight is in either 'Bright' or 'Dim' modes. If it is set to 'Off', the functions do not respond.

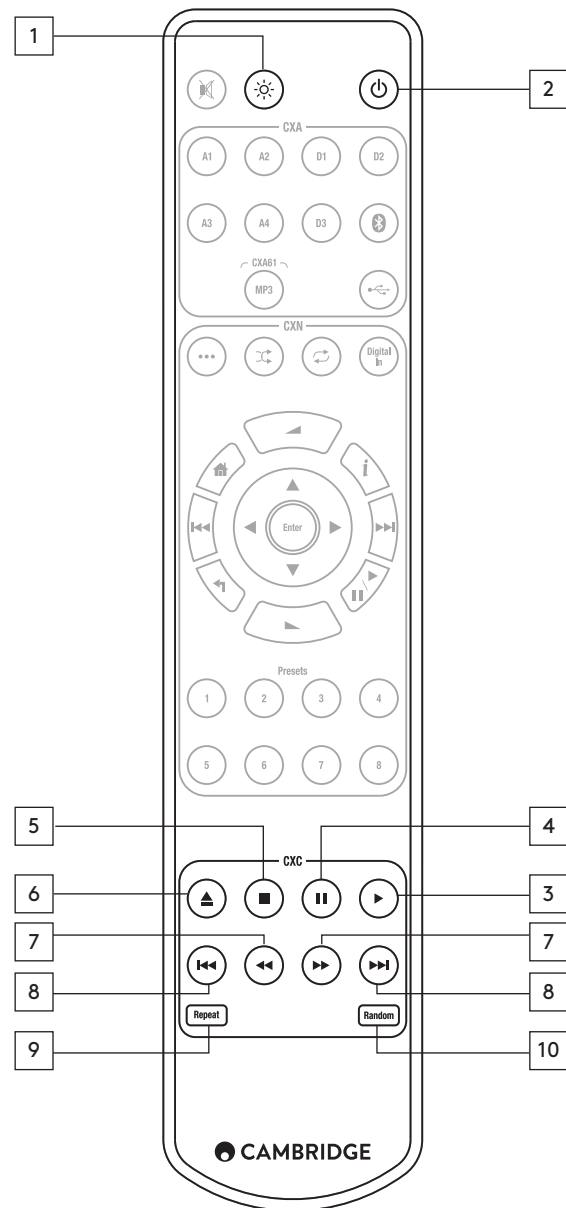

Operating instructions

LOADING AND UNLOADING DISCS

1. Press the Open/Close (▲) button.
2. When the disc tray has opened fully, place a disc carefully in the tray with the label side facing up.
3. To close the disc tray, press the Open/Close (▲) button again. When the tray, with a correctly loaded disc, is fully closed the CD player will read the disc and display the content information.
4. The disc tray can be opened at any time by pressing the Open/Close (▲) button. Only remove the disc after the tray has fully opened.

Note:

- Do not put anything except a compact disc into the tray. Foreign objects may damage the mechanism.
- Do not force the tray by hand during the opening and closing operations.
- To avoid dirt and dust entering the mechanism, keep the disc tray closed.
- If the compact disc is badly scratched or too dirty, the player may not be able to read it or play it.
- Never load more than one disc into the disc tray at any time.

NORMAL DISC PLAY



This unit has been designed to play compact discs, recordable CDs (CD-R) and re-writable CDs (CD-RW) bearing the identification logo shown here. No other discs can be used. Any CD-R/CD-RW discs should contain properly recorded TOC (Table of Contents) information so that they can be played back. This unit can play only the discs recorded in the CD-DA format designed for music reproduction. Do not attempt to play a disc containing other data, such as a CD-ROM for PCs with MP3 or WMA files, on this unit.

1. Switch on your amplifier and set its input selector to the correct position. Adjust the volume control to a minimum.
2. Press the Open/Close (▲) button to open the disc tray and load a disc.
3. Press the Open/Close (▲) button again to close the tray. The CD player will read the disc.
4. To begin playback, press Play (▶).
5. When the last track has finished playing, the display will return to Table of Contents (TOC).
6. To stop the disc at any point, press the Stop (■) button. Pressing the Pause (⏸) button while the disc is playing will pause the disc and illuminate the pause icon on the display. Playback can be resumed by pressing the Play (▶) button again.

LOCATING A SPECIFIC TRACK DURING PLAYBACK

1. A single short press of the Skip/Scan (▶▶) button will take you to the beginning of the next track on the CD. Repeat as necessary.
2. A single short press of the Skip/Scan (◀◀) button will take you to the beginning of the previous track.

LOCATING A SPECIFIC TRACK WHEN PLAYBACK IS STOPPED

1. A single short press of the Skip/Scan (◀◀) button will skip between tracks.
2. Press and hold to scroll rapidly through tracks.
3. Press the Play (▶) button to start playback from the selected track.

REPEATING DISCS AND TRACKS

1. Ensure that the disc is loaded.
2. Press the Repeat button on the remote control. 'Repeat All' will appear on the display. Press the Play (▶) button. The whole disc will now be repeated until the function is turned off.
3. To repeat a specific track, press the Repeat button twice while the track is playing. 'Repeat Track' will appear on the display. Press Play (▶) and the selected track will now repeat until the function is turned off.

Alternatively, press the Repeat button twice, select the chosen track using the numerical buttons on the remote control and press Play (▶).

4. Press the Repeat button again either before or during playback to turn off the repeat function.

PLAYING TRACKS IN RANDOM ORDER

1. Ensure that a disc is loaded.
2. Press the Random button on the remote control. 'Random' will appear on the display.
3. Press the Play (▶) button. The CD player will now play the entire disc in random order.

It is also possible to press the Random button during playback to listen to tracks in random order.

4. Press the Random button to exit the Random function. The disc will continue playing to the end in the correct order.
5. Press the Stop (■) button at any time to stop the disc.

Note: Selecting 'Random' mode when 'Repeat Track' has been selected will automatically cancel 'Repeat Track' mode.

USING THE SET-UP MENU

The CXC allow the setting of some options related to Auto Play and Auto Power Down.

1. Press and hold the Stop (■) button for five seconds to open the setup menu.
2. Scroll through the menu (shown below) using the Skip/Scan (◀◀ ▶▶) buttons.
3. Press the Play (▶) button selects a sub-menu. Scroll through submenu options with the Skip/Scan (◀◀ ▶▶) buttons. The default setting is indicated by the symbol.
4. Select an option by pressing the Play (▶) button.
5. Return to the sub-menu or exit the options menu by pressing the Stop (■) button.

Note:

- It is not possible to access the set-up menu during disc playback.
- The Stop (■) button on the remote control cannot be used to open the set-up menu. Once you have accessed the menu, however, the remote control can be used to scroll through and select sub-menu options.

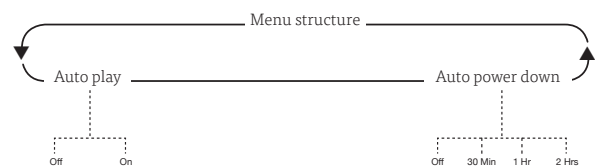

AUTO PLAY SETTING

If required the CXC can automatically play disks inserted into the drawer without the Play (▶) button having to be pressed. Auto Play is simply enabled in the menu when desired. The default setting for Auto Play is 'Off'.

AUTO POWER DOWN SETTING

If desired the CXC can shut itself down if not used for a period of time. Power down after an inactive period (no disk playback or any functions of the player used) of 30, 60 or 120 minutes can be selected. The default setting for Auto Power Down is '30 min'.

Custom installation (C.I.) use

The CXC feature a Control Bus input/output that allow un-modulated remote control commands (positive logic, TTL level) to be received electrically by the unit and looped to another unit if desired. These control commands are typically generated by custom installation (multi-room) systems or remote IR receiver systems. The Control Bus sockets are colour-coded orange.

An IR Emitter Input is also provided that allows modulated IR remote control commands to be received electrically by the unit. Commands on this input operate the unit only and are not looped out demodulated on the Control Bus Output.

In addition the units feature 'direct' IR/Control codes as well as toggle codes for some of their features to simplify programming custom installation systems. Special direct On/Off commands can be accessed on the supplied remote control for teaching into C.I. systems or learning remotes as follows:

1. To send a discrete Power On command, press down the skip back button and the power toggle button.
2. To send a discrete Power Off command, press down the skip forward button and the power toggle button.

A full code table for this product is available on the Cambridge Audio website at www.cambridge-audio.com.

Technical specifications

Total correlated jitter	<140pS
S/PDIF output impedance or TOSLINK optical	<75ohms
Digital audio outputs	S/PDIF coaxial and TOSLINK optical
Maximum power consumption	25W
Standby power consumption	<0.5W
Dimensions (H x W x D)	85 x 430 x 315mm (3.3 x 16.9 x 12.4")
Weight	4.7kg (10.3lbs)

Troubleshooting

THERE IS NO POWER

Ensure the AC power cord is connected securely.

Ensure the plug is fully inserted into the wall socket and is switched on.

Check fuse in the mains plug or adaptor.

THE PLAYER WILL NOT READ THE DISC

Check the disc is not loaded upside down.

Check that the disc is not too scratched or dirty.

THERE IS NO SOUND

Ensure that the amplifier is set correctly.

Check that the interconnects are inserted correctly.

THE DISC IS SKIPPING

Check that the disc is not too scratched or dirty.

Ensure the player is on a firm surface and not subject to vibrations.

THERE IS A HUM COMING FROM THE SPEAKER

Ensure that all cable connections are secure.

THE REMOTE HANDSET WILL NOT FUNCTION

Check that the batteries have not expired.

Ensure that nothing is blocking the remote sensor.

In the event that the above solutions do not remedy your problem, please consult our frequently asked questions (FAQ) section on our website: techsupport.cambridgeaudio.com

You can also use this facility to post a question to our Technical Support team.

For all servicing, in or out of warranty, please contact your dealer.



WWW.CAMBRIDGEAUDIO.COM

Gallery Court, Hankey Place
London
SE1 4BB
United Kingdom

Cambridge Audio is a brand of Audio Partnership Plc.
Registered in England No. 2953313

APxxxxx/1