

■ SPECTRAL

Smart furniture

N° 2 2015



**it's
a smart
world!**

FURNITURE THAT
CAN DO MORE
THAN FLAP OPEN
AND SHUT.

Contents

TWENTY	12-35
SCALA	36-51
COCOON	52-67
BRICK	68-79
DISC	80-87
MUSIC BOX	88-91
COCKPIT	92-93
TRAY	94-95
HIGH-END	96-97
CLASSICS	98-101
AMENO	102-103
CATENA	104-105
Accessories	106-107
Docks + Sound Systems	108-109
Quality	110-111
Colours	112-113

**it's
a smart
world!**

The world is becoming smart.

So is your furniture.

SPECTRAL has made a name for itself for many years with innovative solutions, such as integrated sound systems, hidden cable runs and projector drawers. “SPECTRAL: making technology invisible” is the motto under which we have provided solutions for a tidy living room with entertaining technology.



However, as smart as the new phones and tablets are, they have one major drawback: While we are content with the limited image size and sound quality of mobile devices when we are on the go, at home we are much more discerning.



We want to enjoy music in the best quality and volume possible, have our pictures run in a slide show and stream films from the Internet or cloud in HD on our televisions from the comfort of our sofas.

Now we are facing new challenges: A few years ago, information technology, consumer electronics and telecommunications were still independent areas, but – thanks to the smartphone – they are inseparable today:

People write emails, surf the internet, watch films, take pictures, listen to music, send messages and make phone calls – all using a single device.

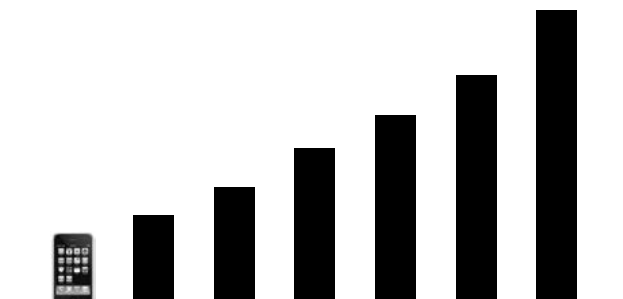

Smartphone distribution since the introduction of the iPhone in 2007



SPECTRAL has made it its mission to integrate this digital world in an attractive living environment. Analogue to smartphones and smart TVs, we develop “smart furniture” – elegant home furniture with additional smart features built in.

SHE

»Smart furniture« by SPECTRAL brings
»Home« and »Entertainment« together:

She is delighted with her elegant home
with ample storage space and room for decoration.
He is thrilled with world-class entertainment.

She + He

are like:

Home + Entertainment

She wants

He wants

Easy care furniture + Future proof furniture

She wants

He wants

Room for decoration + Room for technology

She wants

He wants

Concealed speakers + High-performance speakers

She wants

He wants

The latest colours + The latest equipment

She wants

He wants

Easy-to-use technology + Simply the latest technology

She wants

He wants

Magnificent optics + Magnificent acoustics

Our furniture offers both

■ SPECTRAL
Smart furniture

Smart solutions.

For a smart home

Concealed speakers and cables for a tidy living room.

The technology chaos that rules many living rooms leaves us speechless: intrusive speakers, metres of visible cables, five different remote controls and often an iPhone with charger cable lying about. »Smart furniture« by Spectral finally brings order into the living room: Speakers are built into the furniture. Cables are hiding there as well. A host of remotes are replaced by just one. iPhone and iPad can have their own space to charge up and play. And thanks to the infrared link system, you can even control all your devices when the flaps are closed.



Loudspeakers, subwoofers and cables everywhere



Integrated loudspeakers and subwoofers, no cables



Invisible integrated loudspeaker system behind fabric-covered flap

Spectacular sound systems for an impressive home cinema atmosphere.

Our concealed in-furniture sound systems are produced by Canton, Germany's leading loudspeaker manufacturer. The high-performance systems feature integrated subwoofers and digital surround receivers and offer you the choice between impressive virtual surround sound or powerful stereo acoustics.



A single remote for TV and sound system.

All new Spectral sound systems come equipped with an IR programmable feature. You no longer need additional remote controls or complicated universal remote controls; you can now control your sound system with your regular TV remote control.





Ample storage space for pretty and useful things.

Thanks to the compact integration of technology, furniture by Spectral offers you lots of additional space for books, vases, plants and other decorations. Anything you want to remain unseen or kept dust-free can be hidden behind a door, flap or drawer.

Wireless content streaming via iPhone and iPad.

Get comfortable on your couch and enjoy wireless streaming of all your content, including pictures, songs and videos, from your mobile device to the TV and sound system.

A matching media player will provide even more entertainment.



We offer matching side tables for your furniture

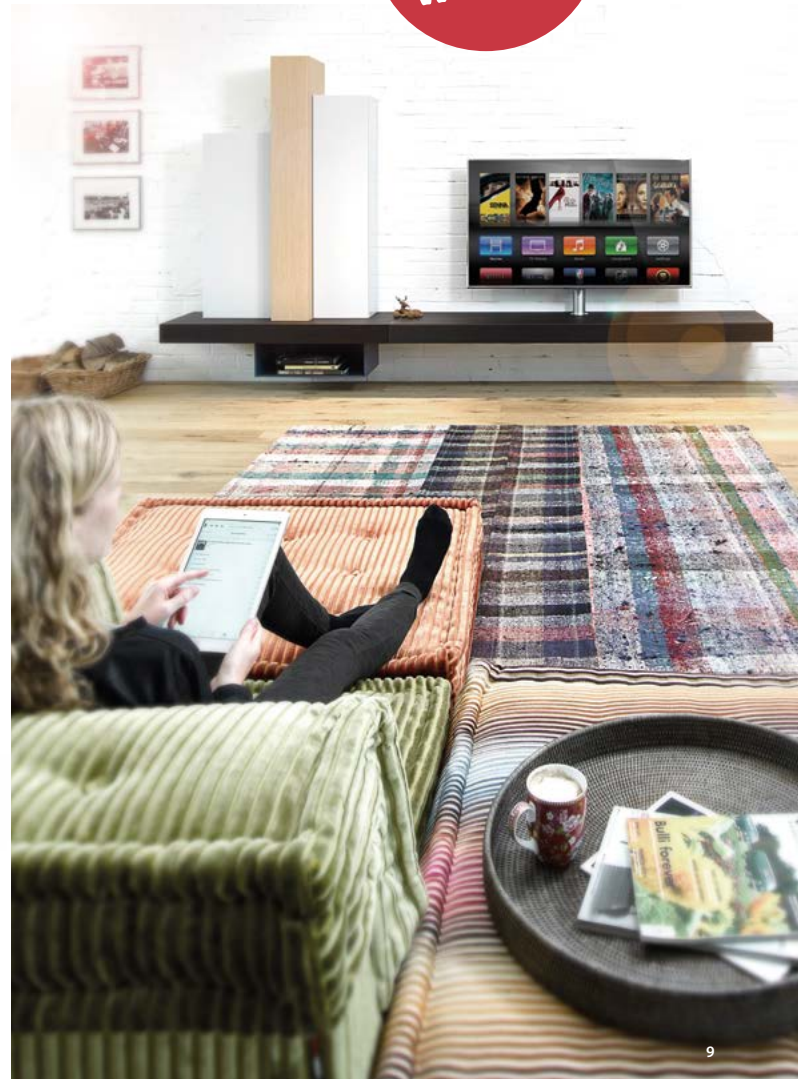

**ALL
YOU
NEED
IS**



Internet



Smartphone or tablet

iPhone, iPad and everything else



TV + media player

e.g. Apple TV



■ **SPECTRAL**
Smart furniture

One solution. Endless possibilities.

The combination of mobile device, TV, media player and Spectral smart furniture opens the door to all modern entertainment options:

Wireless streaming of all your images, music and videos from your iPhone or iPad to your TV and sound system. You can access YouTube and all other online video and music services via the internet. And an optional Blu-ray player also allows you to play your old CDs/DVDs and new Blu-rays.



TWENTY







TWP02

TWENTY is all in one.

ROOM FOR THE BEAUTIFUL THINGS AND PLENTY OF STORAGE SPACE.
WHATEVER YOU DON'T WANT TO BE SEEN REMAINS HIDDEN.

A bit of art on the shelf, favourite books always in view.
Lots of storage space above, a little to the sides.
And everything floating nicely, with individually arranged wall cabinets.
What you can do, if you have the opportunity to ...



Model series

TWENTY







TWP06

Room for plates and decoration.
Concealed speakers.
No visible cables lying about.

FOR THOSE WHO PREFER TO HEAR SPEAKERS, RATHER THAN SEE THEM.

With TWENTY, the speakers are invisibly integrated into the furniture. They produce an incomparably rich surround sound without all those cables scattered around .

And what about the amplifiers and subwoofers?

Both are integrated in the sound system.
So that they, too, are out of sight.

THE XTA1 SOUND SYSTEM

Wide, black, strong. Less than 7 cm high, the sensationally flat 2.1 virtual surround system XTA1 scores with its unbelievable sonorous bass. Depth you can hear, not see. Yet, the system can do more than surround mode; it equally stands out in stereo mode. And the option to play music directly from your smartphone via Bluetooth is extremely practical.

TWENTY is easy.

TWENTY IS A PURIST, EASY-TO-CONFIGURE MODULAR FURNITURE PROGRAMME.
IT LEAVES OUT EVERYTHING THAT MAKES FURNITURE PLANNING AND LIFE COMPLICATED.

A grid dimension of 20 cm makes planning home entertainment systems with Twenty child's play. It's like a game of Tetris: the tall, flat and square box modules are simply placed next to each other or stacked on top of each other. Since the elements are always flush with each other, TWENTY can be extended with additional furniture elements at any time.





TWP03

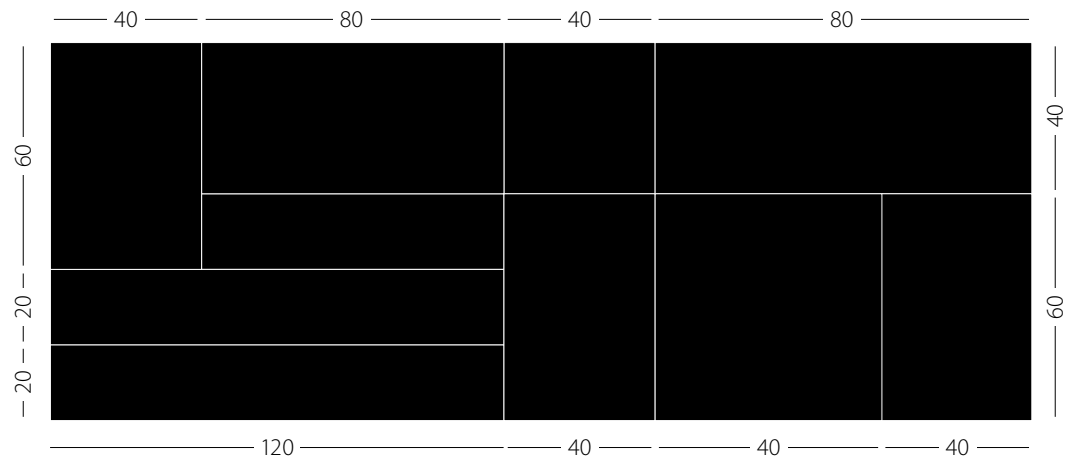



TWENTY connects.



The model series' elegant »Connect« side tables TWENTY acts as a charging station for your iPhone or iPad, and a control centre in your living room. At the press of a button, you can stream music, photos, videos or web content to your TV or sound system from the comfort of your sofa.





TWENTY is colourful.

SOME THINGS HAVE A CERTAIN SHAPE
AND SOME A CERTAIN COLOUR.

She likes it homely; he prefers things
in classic black, white or wood. Just as well TWENTY
comes in a variety of colours that make everyone happy.





TWP01



TWENTY is high-end.

FURNITURE FOR DREAMING AND ENJOYING.

The sound that emanates from a Spectral VRA sound system cannot be described by words. Canton itself describes them as by far the best front surround sound system in the world. Well, for us it is the most beautiful front surround sound system in the world.



Spectral recommends WiMP Hi-Fi, the only music streaming service that provides its entire music catalogue in uncompromising sound quality. For more information about WiMP, visit wimp.de.

Beauty...





...full

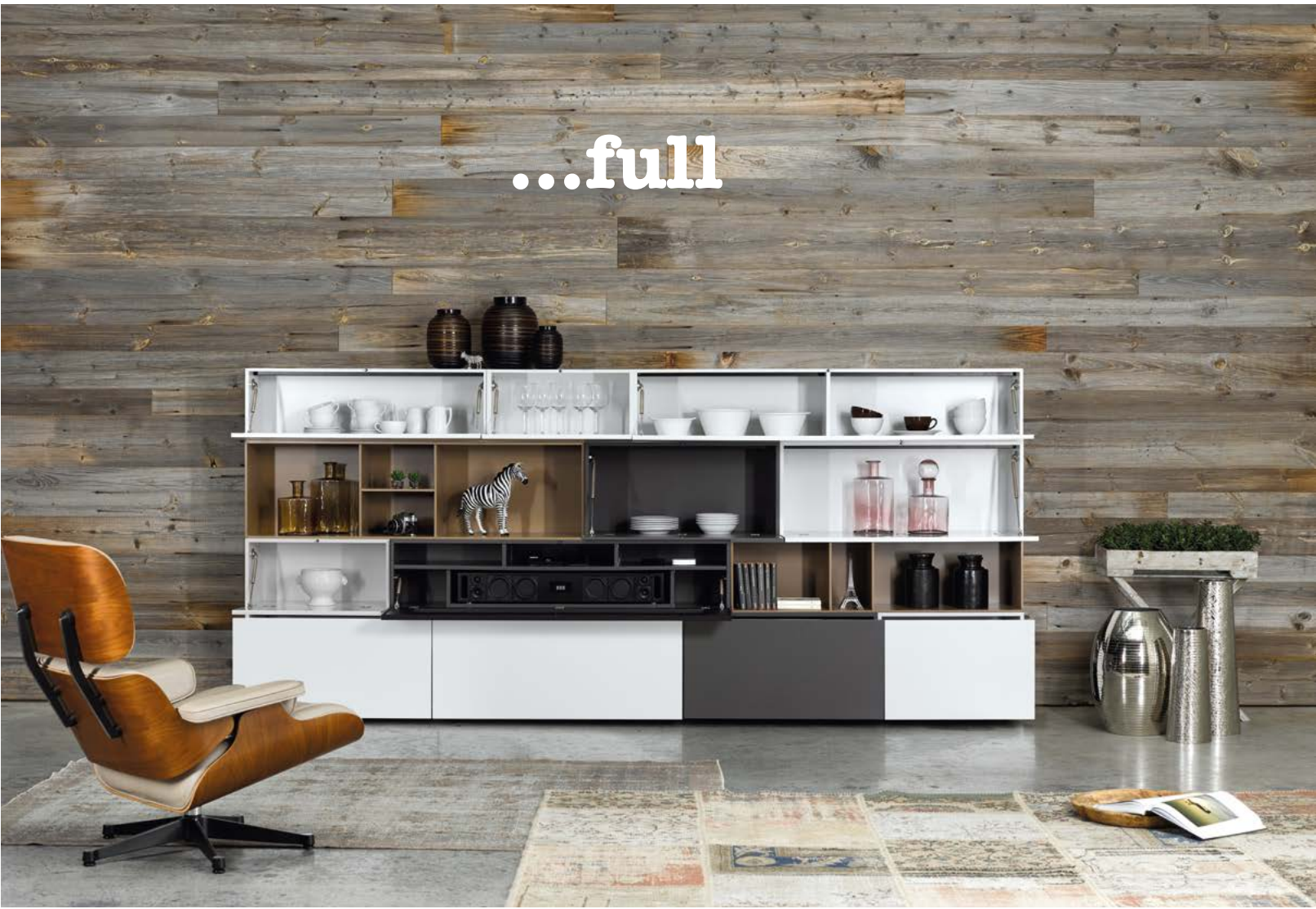

TWP04







TWP07

TWENTY is endless.

With TWENTY, the home cinema components are entirely invisible.
That means you can fully focus on furnishing, decorating and living.

And if you need even more beautiful storage space,
you simply extend TWENTY along the next wall.



TWP06

The smartest way to customised furniture.

The TWENTY concept

TWENTY IS A PURIST, EASY-TO-CONFIGURE MODULAR FURNITURE PROGRAMME WITH VARNISHED AND VENEERED SURFACES. IT LEAVES OUT EVERYTHING THAT MAKES FURNITURE PLANNING AND LIFE COMPLICATED.

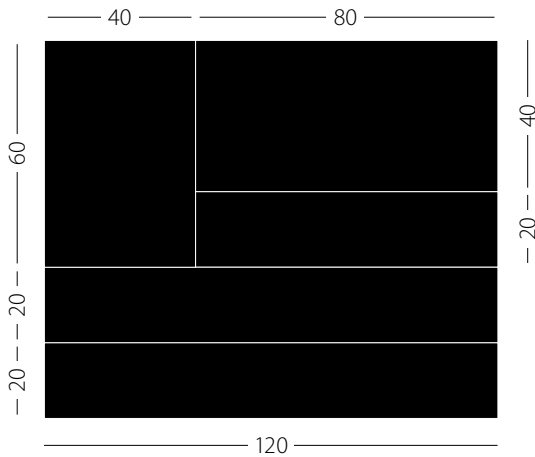

SIMPLE PLANNING THANKS TO A GRID DIMENSION OF 20 CM.

A grid dimension of 20 cm makes planning home entertainment systems with TWENTY child's play. It's like a game of Tetris: the tall, flat and square box modules are simply placed next to each other or stacked on top of each other. Since the elements are always flush with each other, TWENTY can be extended with additional furniture elements at any time.

SURFACES AND COLOURS.

TWENTY comes with semi-matte varnished or veneered surfaces. Choose from 26 colours and the three veneers Sand Oak, Indian Walnut and Dark Oak. The fabric front covers for the speakers are available in black, silver and carbon.

UNLIMITED DESIGN OPTIONS.

The element widths vary in size from 20 cm to 160 cm, the element heights from 10 cm to 180 cm. Elements are available in depths of 38 cm and 48 cm. Matching shelf boards with depths of 28 cm and 48 cm are also available. The elements come in a choice of open design, with a flap, door, drawer or fabric cover. The fronts in the TWENTY range are handleless and operated by a touch system. TWENTY is mounted on the wall, on a sledge foot or a flat base.

HIDDEN SOUND.

TWENTY offers four sound integration options. We offer the SCA3, the BRA2 and the VRA2, three tried and trusted high-end sound systems by Spectral. All systems are integrated into the furniture and concealed behind a fabric-covered front. The slim design XTA1 only 7 cm in height was designed especially for TWENTY and is concealed in a slim music board measuring a mere 10 cm. Alternatively, you can choose box elements for soundbars by different manufacturers.

ROTATING TV MOUNT.

Virtually all commercial TVs can be fixed to this rotating universal TV mount. The cables are run in the column hidden from view. The bracket rotates in all directions, enabling you to watch movies from every angle.

It's beyond simple - your specialist retailer will configure your TWENTY in line with your expectations with a 3D planning software.



69	ZITRUSGELB	
48	FEUER	
32	KORALLE	
47	TOMATENROT	
40	WEINROT	
34	AUBERGINE	
52	MAUVE	
30	JADE	
50	MOOSGRÜN	
56	WASSERBLAU	
68	STAHLBLAU	
57	TAUBE	
67	ALUSILBER	
41	WEISS	BASISFARBE
27	GRAU-WEISS	BASISFARBE
29	PUDER	
39	ELFENBEIN	
28	ROSENHOLZ	
59	KIESELSTEIN	BASISFARBE
63	NOUGAT	
65	MOCCA	
60	STEINGRAU	
45	ASPHALT	
66	GRANIT	BASISFARBE
37	SCHIEFER SCHWARZ	BASISFARBE
46	SCHWARZ	

Colours



Veneers



Model series

SCALA

Home is
the most beautiful place.

AS MUCH AS WE ENJOY TRAVELLING - AT SOME POINT
OUR DESIRE TO BE HOME TAKES OVER.

SCALA by SPECTRAL is one reason. With its enormous choice of low boards and wall cabinets, this elegant modular furniture offers tremendous freedom for the design of your very own home. Integrated sound systems and docking option for mobile devices make sure you never get bored at home even after you've decorated.



Integrated sound system
with fabric-covered flap



scratch-resistant glass surface
in over 2,000 colours



Wall cabinets
with glass side panel



SCALA combination with wall-mounted low boards and wall cabinets,
docking station for mobile devices, rotating TV mount



Sophisticated
flap mechanism
with soft closing mechanism



Anodised aluminium handle

Only flying is **more exciting.**

Give your living room a touch of lightness with a levitating SCALA, matching wall cabinets and a SPECTRAL MUSIC BOX for carefree musical enjoyment thanks to the docking station for mobile devices.

2x SCH37, SMB1-iP, SC1650-SL and SC1650-TX in NCS colour





Scala has **many faces.**

AS A STAND-ALONE LOW BOARD OR IN COMBINATION
WITH WALL CABINETS.

SCALA opens the door to countless possibilities for the design of your living room. A choice of over 2,000 glass colours allows you to set additional accents.



Scala SC1651 in selected NCS colour (taupe) with fabric flap in carbon (CF), sound system and docking station for mobile devices



2 x SCH1000, SCH48, SC1651W-TX-iP in NCS colour (taupe)



SCH37, SMB1-iP, SC1100W-SL and SC1650W-TX in NCS colour (taupe)



SCH37, SCH1100 in NCS colour (coral), SC1100W, SC1651W-TX-iP

More than meets the eye.

Scala is now available with a fabric-covered flap. It beautifully hides an optional integrated sound system for an impressive sound experience. What's more, it offers space for devices such as media servers, game consoles or Blu-ray players which won't overheat thanks to the fabric flap in the furniture.



Scala SC1651 in silver with fabric flap in silver,
rotating TV mount, docking station for mobile devices and BRA2 sound system

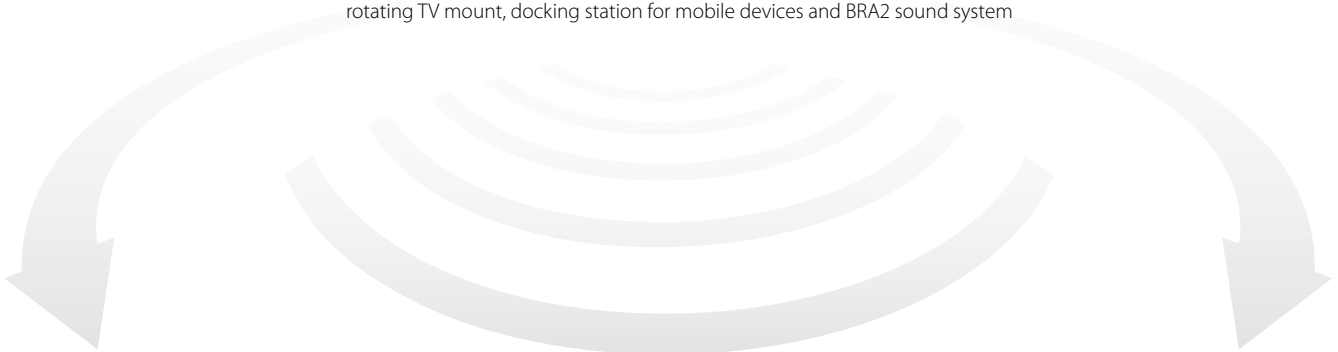

One Scala

Many sound systems.

Whether you choose a Spectral signature sound system or a soundbar from a different manufacturer, you can unleash the sound from behind SCALA's fabric-covered front.

SCALA SC1656

Universal soundbar element, suitable for many soundbar systems with large subwoofers. For instance, SONOS Playbar and subwoofers. Two additional compartments for devices.



SCALA SC1654

Universal soundbar element, suitable for many soundbar systems. For instance, SONOS Playbar.





SCALA SC1652 and SAMSUNG soundbar with subwoofers



Scala SC1653 and SONOS Playbar with subwoofers



SCALA SC1104 and BOSE sound system



SCALA SC1654 and BOSE soundbar with subwoofers

Solutions for SPECTRAL sound systems SCA3 and BRA2

Models SC1101 and SC1651 have been optimised for use with SCA3 and BRA2 sound systems.



SCALA SC1101 and SPECTRAL sound system SCA3



SCALA SC1651 and SPECTRAL sound system BRA2



Scratch-resistant safety glass with **satin** finish (optional)



Scratch-resistant safety glass with **high-gloss** finish (standard)



We will **dock** you.

If you own an iPhone or iPad, you will have a lot of fun with Scala. Stored music, pictures and videos can be streamed directly to your television or sound system. The concealed docks can easily be interchanged. That way, your furniture stays future proof.



Integrated handle
in anodised
Aluminium

Subwoofer opening (SP)
Base opening with fabric cover
for subwoofer
(Downfire) integration,
e.g. Loewe Individual Subwoofer.



Drawer (SL)
with sophisticated soft closing mechanism

General information

Glass surfaces:	Black (BG), snow (SNG), silver (SV), choice of NCS colour (10% surcharge per shade), choice of high-gloss or satin glass (SAT)
Top panel:	Coloured glass, interchangeable (exception: SCH1000)
Base panel:	Low boards with cable recess as standard
Cabinet colour:	Lowboards and closed wall cabinets interior: Black Open wall cabinets: Black (SW), white (WS) or carbon (CB)
Front:	Furniture elements: coloured glass, sound elements: Fabric flap
Fabric front:	Choice of black (BF), silver (SF) or carbon (CF)
Glass shelves:	Clear glass, adjustable spacing 32 mm
Glass side panel:	If several elements are combined, the position of the glass side panels must be indicated (L for left and R for right and LR for left and right). Exception: open wall cabinets SCH37 and SCH48: glass side panels are not available. Vertical wall cabinet SCH1000: Glass side panels always LR
Interior rear panel:	Open wall cabinets: Black (BG), white (SNG) or carbon (CG), the colour of the interior rear panel must always match the cabinet colour, 10% surcharge for choice of colour or mirror
Base:	Aluminium, adjustable height
mechanism:	Pull to open, flaps have gas springs, drawers with soft closing mechanism
Subwoofer opening:	Incl. fabric cover
Load:	Freestanding elements: Total load max. 60 kg Wall-mounted elements: Total load max. 50 kg, top panel: max. 45 kg, glass shelves: max. 15 kg, drawers: max. 20 kg per drawer compartment, open wall cabinets: max. 10 kg
Low boards	Also available with wheels (R) or wall-mounted (W), wheels and back panels for room dividers are not available for low boards with drawer. Models with drawers/glass shelves must be wall-mounted

Low boards with a width of 482 mm

SC560

Flap, 1 compartment, 1 shelf
Optional subwoofer opening (SP)
Surcharge for satin glass (SAT)



SC560-SL

as SC560 with drawer
with TV mount TX, internal drawer
dimensions are reduced to 468 x 281 mm (W x D)
Surcharge for satin glass (SAT)

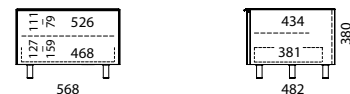

SC1100

Flap, 2 compartments, 2 shelves
Optional subwoofer opening in right compartment (SP)
Surcharge for satin glass (SAT)

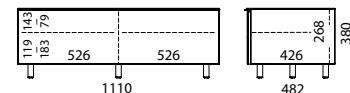

SC1100-SL as SC1100 with drawer

With TV mount TX, internal drawer dimensions are reduced to 468 x 281 mm (W x D)
Surcharge for satin glass (SAT)

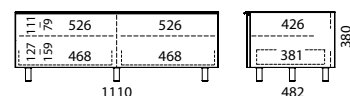

SC1101 Sound element for SPECTRAL Sound System BRA2/SCA3

Fabric-covered flap, 2 upper compartments for devices,
1 lower compartment for sound systems
(only available for BRA2 or SCA3)
Surcharge for satin glass (SAT)

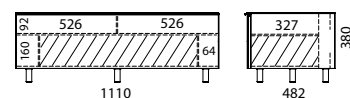

SC1104 Universal Soundbar Element

Fabric-covered flap, 2 compartments
incl. universal metal shelf for soundbars
Optional subwoofer recess in the right compartment (SP)
Max. soundbar dimensions: 995 x 165 x 90 mm (W x H x D)
Surcharge for satin glass (SAT)

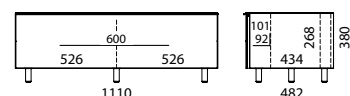

Low boards with a width of 482 mm



SC1650

Flap, 3 compartments, 3 shelves
Optional subwoofer opening in right compartment (SP)
Surcharge for satin glass (SAT)

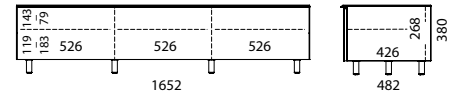

SC1650-SL as SC1650 with drawer
with TV mount TX, internal drawer dimensions
are reduced to 468 x 281 mm (W x D)
Surcharge for satin glass (SAT)

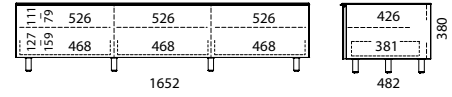

SC1651 Sound element for SPECTRAL Sound System BRA2/SCA3
With fabric-covered flap, 3 upper compartments for devices, 3 lower compartments
(1 compartment for sound systems, only available for BRA2 or SCA3)

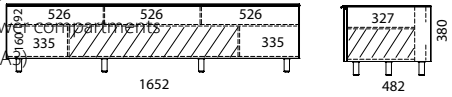

Surcharge for satin glass (SAT)



SC1652 Universal Soundbar Element
With fabric-covered flap, 2 shelves
Subwoofer opening in right compartment
Optional TV mount usually positioned to the left
Max. soundbar dimensions: 1000 x 225 x 230 mm (W x H x D)
Max. subwoofer dimensions: 480 x 235 x 420 mm (W x H x D)
Surcharge for satin glass (SAT)

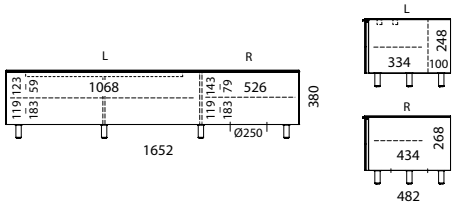

SC1653 Universal Soundbar Element
With lower fabric-covered flap, upper flap with glass-front,
2 shelves, Subwoofer opening in right compartment
Optional TV mount usually positioned to the left
Max. soundbar dimensions: 1000 x 240 x 230 mm (W x H x D)
Max. subwoofer dimensions: 480 x 250 x 420 mm (W x H x D)
Surcharge for satin glass (SAT)

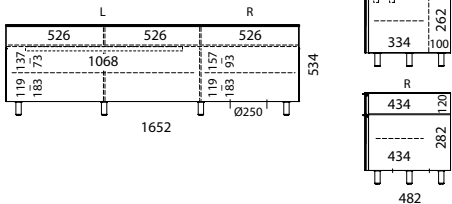

SC1654 Universal Soundbar Element
With fabric-covered flap, 2 shelves (left and right
compartment), incl. universal metal shelf for soundbars
Max. soundbar dimensions: 1530 x 170 x 90 mm (W x H x D)
Optional subwoofer opening in right compartment (SP)
Surcharge for satin glass (SAT)

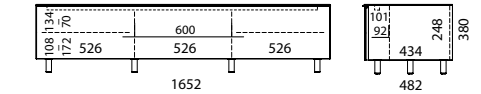

SC1656 Universal Soundbar Element
Suitable for many soundbar systems with large subwoofers,
with lower fabric-covered flap, upper flap with glass-front, 1
shelf (right compartment), incl. universal metal shelf for soundbars
Max. soundbar dimensions: 1530 x 200 x 90 mm (W x H x D)
Max. subwoofer dimensions: 400 x 400 x 305 mm (W x H x D)
Optional subwoofer opening in left compartment (SP)
Surcharge for satin glass (SAT)

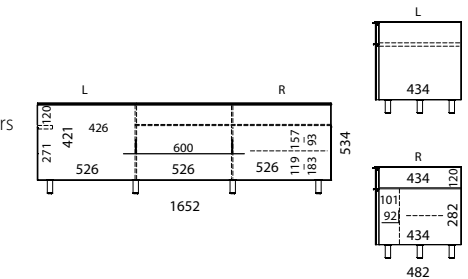

Wall cabinets

SCH37

Open wall cabinet, 373 mm deep, glass rear panel
also available in choice of NCS colour or mirrored (10% surcharge per shade)
Surcharge for satin glass

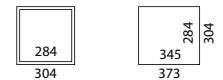

SCH48

Open wall cabinet, 482 mm deep, interior rear panel
also available in choice of NCS colour or mirrored (10% surcharge per shade)
Surcharge for satin glass

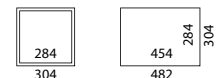

Wall cabinets



SCH1100

Flap, 2 compartments, 2 shelves
Surcharge for satin glass

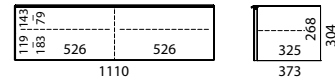

SCH1101-SL

2 drawers, 4 compartments
Surcharge for satin glass

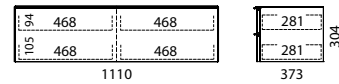

SCH1650

Flap, 3 compartments, 3 shelves
Surcharge for satin glass

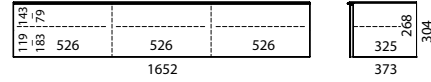

SCH1000

Vertical wall cabinet, with hinged door
choice of door left (TL) or door right (TR)
2 shelves
Glass side panels always LR, irrespective of position
Surcharge for satin glass

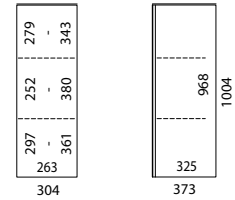

Accessories



Internal drawer elements with mirrored front

for centre compartment of low board SC1650

SC-SL1650

for low board 1650 **without** TX mount
Drawer depth: 381 mm

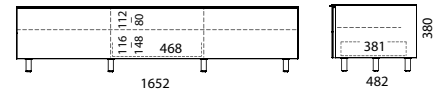

SC-SL1650-2

for low board 1650 **without** TX mount
Drawer depth: 281 mm

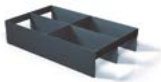
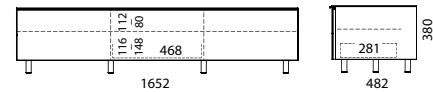

CDE6 CD/DVD tray for drawers

for low boards (482 mm deep)
1 tray per drawer compartment possible
168 SlimLine CDs, 84 CDs or 32 DVDs/Blu-rays per tray

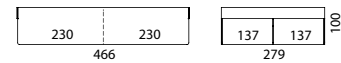

Inside rear mirror

for wall cabinets with flap

SCG5 for SCH1100 (Set, 2 pcs., 524 x 266 x 4 mm)

SCG6 for SCH1650 (Set, 3 pcs., 524 x 266 x 4 mm)

SCG7 for SCH1000 (Set, 1 pc., 966 x 261 x 4 mm)



Connecting foot set (SCF1)

for low boards with a depth of 482 mm, Optional for connecting more than 1 cabinet (2 pcs)

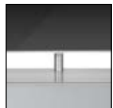

TV mount (TX)

for low boards with a depth of 482 mm, rotating, suitable for VESA 200 x 200 up to 400 x 400
max. load 40 kg, incl. cable recess at the top (CA), position: centre,
for SC1652 and SC1653: 654 mm from the left exterior edge

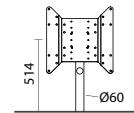

Universal Adapter SPMMOVIE

VESA 100 x 100 up to 600 x 400

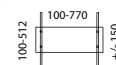

ZU1868 TV cover

For elements with TV mount TX
suitable for many TV models from 46" with VESA 400 x 400
choice of high-gloss or satin glass
Surcharge for satin glass

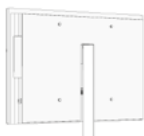
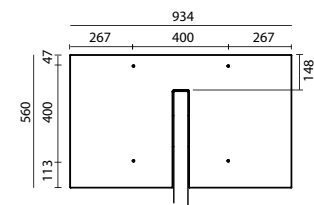

Infrared link system

For controlling your devices with closed furniture flaps

Accessories



- Sound systems** for sound elements SC1101 and SC1651
BRA2 virtual surround sound system incl. Bluetooth 4.0 and HDMI interface
SCA3 sound system incl. Bluetooth 4.0 interface

Fitting frame for soundbars for low boards SC1652 and SC1653, suitable for Loewe Sound Projector SL Individual

- ZU1810*** Soundbar fitting frame for SC1652
ZU1810* Soundbar fitting frame for SC1653

A separate adapter is also required for soundbars by other manufacturers.

- ADS2**** Adapter for SAMSUNG soundbar
ADB04** Adapter for BOSE soundbar
ADSN1** Adapter for SONOS Playbar

*Please contact us for retrofit options | ***Please contact us for current suitable soundbar models

Soundbar adapter for low boards SC1104, SC1654 and SC1656

- ADB03** Suitable for BOSE® Soundbar CineMate® 1SR, CineMate® 130, Lifestyle® 135
ADSN1 Adapter for SONOS Playbar



Cable recess at the top (CA) for low boards, cable recess in top panel, position: centre, for SC1652 and SC1653:654 mm from the left exterior edge, free if ordered with TV mount (TX)

Fabric-covered flap (STS) for low boards SC560, SC1100 and SC1650 in black (BF), silver (SF) and carbon (CF) with surcharge as retrofit set for low boards SC560, SC1100 and SC1650 with existing glass front

Wheels / wall-mounted / room divider for low boards with a width of 482 mm

Wheels* (per low board, retrofit options), wall-mounted (per low board, no retrofit options)

Rear panel for room dividers (coloured glass, per low board, please contact us for retrofit options, not available for models with drawers)

- SCR1** Rear panel room divider for SC1100, SC1101
SCR2 Rear panel room divider for SC1650, SC1651
SCR3 Rear panel room divider for SC1653, SC1656
SCR4 Rear panel room divider for SC1104
SCR5 Rear panel room divider for SC1652 and SC1654
SCR6 Rear panel room divider for SC560
Surcharge for satin glass (SCR1, SCR4, SCR6)
Surcharge for satin glass (SCR2, SCR3, SCR5)



Recesses for mobile devices for low boards with a depth of 482 mm

Requires a docking kit (sold separately)

Not available for SC560 with TV mount (TX) or cable recess at the top (CA), position: right; for SC560 position: centre

Docking kits for Apple

- ZU1876** **Docking Kit 26, Apple, iPhone/iPad, HDMI (2015)**
For iPhone 5/5S, iPod touch 5, iPhone 6/6 Plus, iPad mini/mini2/mini3, iPad Air/Air2
Functions: charging, streaming music, photos and videos (HDMI)
- ZU1842** **Docking Kit 23, Apple, iPhone 4/4S, HDMI**
For iPhone 4/4S, iPod touch 4. generations
Functions: charging, streaming music, photos and videos (HDMI)
- ZU1849** **Docking Kit 25, Apple, iPhone 5/5S, Audio**
For iPhone 5/5S
Functions: Charging and streaming music (analogue cinch)
- ZU1877** **Docking Kit 27, Apple, iPad 4, HDMI (2015)**
For iPad 4
Functions: charging, streaming music, photos and videos (HDMI)



- ZU1755** **Media Player for wireless image and audio streaming**
Apple TV for wireless music, image and video streaming

Model series

COCOON



**The most beautiful home cinema
in town.**

SAY GOODBYE TO RANDOM HI-FI COMPONENTS IN YOUR SIGHT –

COCOON, the versatile media furniture by SPECTRAL. In addition to the docking station for mobile devices, COCOON offers plenty of space for integrating a wide range of sound systems. To connect all cables, the magnetically attached glass shelf can simply be removed.



COCOON combination CO1001 as a room divider in snow glass with fabric flap in black, sound system BRA2, rotating TV mount, docking station for iPhone and iPad, wall cabinets in snow glass and choice of NCS colours



Inside handle and mirror

Adjustable height legs in polished stainless steel



Quick and easy cabling thanks to removable, magnetically secured glass shelves



Drawer element with mirrored front and CD/DVD insert







Model series

COCOON

COCOON combination CO1001 as a room divider in snow glass with fabric flap in black (BF), sound system BRA2, rotating TV mount and docking station for iPhone and iPad

Open to everything.

Behind the opaque, fabric-covered front of the technical elements, sound systems can unleash their full potential. The interior can be divided up flexibly to store sound projectors, a subwoofer and centre speaker. Thanks to the opening in the furniture base, you can also use subwoofers with Downfire function inside the furniture.





For **SPECTRAL** sound systems BRA2 or SCA3



For **Sonos** Playbar



For **Samsung** sound systems



For **Bose** sound systems

Two times six equals endless.

Thanks to its modular construction, Cocoon can be expanded in a variety of ways.
Just twelve elements are all you need to arrange your furniture just the way you want it.



3x COH4, 3x COH3, COH1



CO1001
with docking station for iPhone and iPad



Wall cabinet
COH1



Wall cabinet
COH1-SL



Wall cabinet
COH2



Wall cabinet
COH2-SL



Wall cabinet
COH3



Wall cabinet
COH4



COH4, COH3, COH1

CO1000
with docking station for iPhone and iPad



2x COH3

CO1002

with docking station for iPhone and iPad



Furniture element
CO2



Furniture element
CO2-SL



Furniture element
CO3



Furniture element
CO3-SL



Technical element
CO4



Technical element
CO5



CO1000
with docking station for iPhone and iPad

2x COH4, 2x COH2



COCOON is also available with satin glass surfaces. The matte appearance of the glass creates an exciting contrast to the high-gloss polished stainless steel flat base



Drawer element with mirrored front



Rotating TV mount with integrated cable guides, suitable for most TVs

General information



Glass surfaces:	Snow (SNG), silver (SV) and black (BG) choice of NCS colour (10% surcharge per shade), choice of gloss finish or satin glass (SAT)
Top panel:	Coloured glass, interchangeable
Cabinet colour:	Lowboards and closed wall cabinets interior: black open wall cabinets: Black (SW), white (WS) or carbon (CB)
Front:	Furniture elements: coloured glass, technical elements: Fabric flap
Fabric front:	Choice of black (BF), silver (SF) or carbon (CF)
Glass shelves:	Clear glass, adjustable spacing 32 mm
Glass side panel:	When several elements are combined, the position of the glass side panels must be indicated (L for left, R for right, LR for left and right). Exception: open wall cabinet COH4: glass side panels are not available. Vertical wall cabinet COH3: Glass side panels always LR
Base:	Polished stainless steel, adjustable
mechanism:	Furniture/technical elements: pull to open, flaps have gas springs Wall cabinet: push to open
Load:	Total load max. 50 kg, top panel: max. 50 kg, drawers max. 20 kg per drawer compartment, open wall cabinets: max. 10 kg, glass shelves: max. 15 kg
Other:	models with a drawer/drawer insert need to be mounted to the wall! (bracket included)

Special editions

CO1000

1 furniture element CO2 at left,
1 technical element CO5 at centre
with T80 mount
1 furniture element CO2R at right,
optional recess for mobile devices
in the left or right element
Surcharge for satin glass

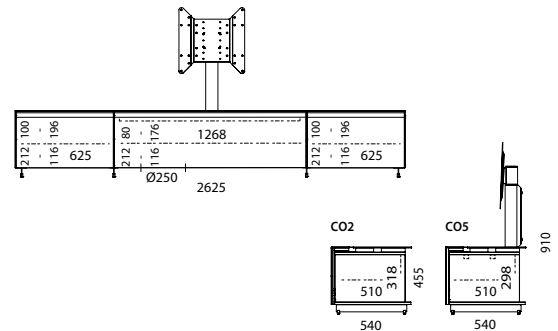

CO1001

1 furniture element CO2 at left,
1 technical element
CO5 at centre, with T80 mount
1 Furniture element CO3 at right
optional recess for
mobile devices in the left or right element
Surcharge for satin glass

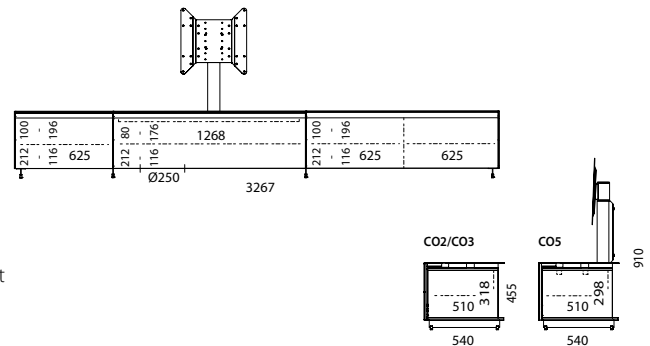

CO1002

1 technical element CO5 at left
with T80 mount
1 furniture element CO2 at right
optional recess for mobile devices
in right element
Surcharge for satin glass

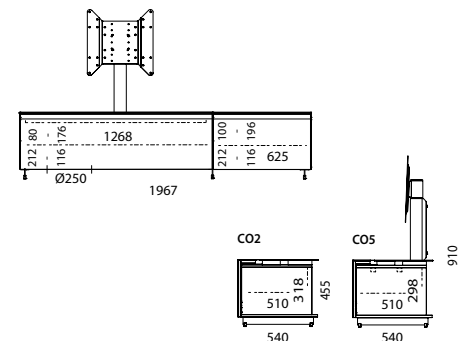

Low boards with a width of 540 mm

Create your personal COCOON arrangement. Please provide a sketch.

Glass side panels are mounted on the outer sides. Please therefore indicate the required positions, where these are to be fitted (L for left and R for right and LR for left and right).

Example: Technical element CO5 with glass side panels left and right: Item number CO5-LR



CO2 Furniture element
Flap, 1 shelf,
top panel with optional cable recess
at the rear edge (no surcharge)
Surcharge for satin glass (SAT)

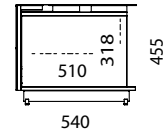
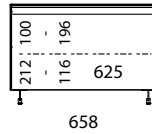

CO2-SL Furniture element
Drawer, 1 shelf,
top panel with optional cable recess
at the rear edge (no surcharge)
Surcharge for satin glass (SAT)

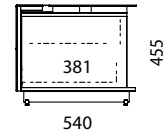
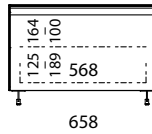

CO3 Furniture element
Flap, 2 shelves,
top panel with optional cable recess
at the rear edge (no surcharge)
Surcharge for satin glass (SAT)

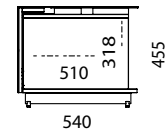
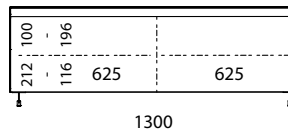

CO3-SL Furniture element
Drawer, 2 shelves,
top panel with optional cable recess
at the rear edge (no surcharge)
Surcharge for satin glass (SAT)

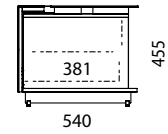
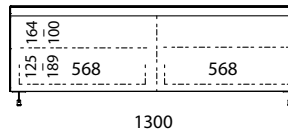

CO4 Technical element
Fabric-covered flap, shelf,
subwoofer opening in base,
top panel with optional cable recess
at the rear edge (no surcharge)
Surcharge for satin glass (SAT)

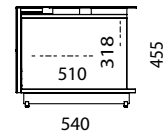
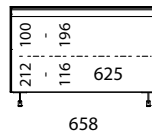

CO5 Technical element
Fabric-covered flap, shelf,
subwoofer opening in base,
Top panel **with** cable recess at the rear edge
(cable recess optional)
Surcharge for satin glass (SAT)

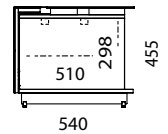
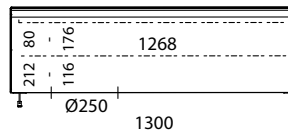

Wall cabinets



COH1 Wall cabinet
choice of lower flap (K) or upper flap (KO)
2 shelves, 2 compartments,
Surcharge for satin glass (SAT)

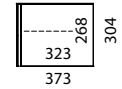
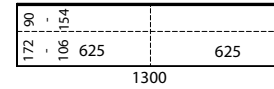

COH1-SL Wall cabinet
1 drawer, 2 compartments
Surcharge for satin glass (SAT)

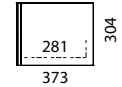
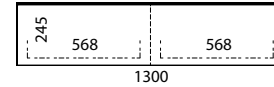

COH2 Wall cabinet
choice of lower flap (K) or upper flap (KO)
2 shelves, 2 compartments
Surcharge for satin glass (SAT)

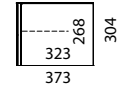
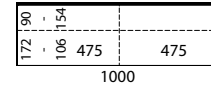

COH2-SL Wall cabinet
2 drawers, 2 compartments
Surcharge for satin glass (SAT)

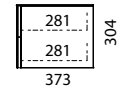
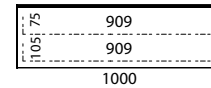

COH3 Wall cabinet
Vertical with hinged door, choice of
door left (TL) or door right (TR)
2 shelves
Surcharge for satin glass (SAT)

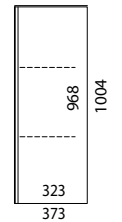
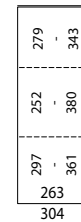

COH4 Wall cabinet
open wall cabinet with interior rear panel in glass.
The cabinet comes with a matt colouring in white (WS), black (SW) or carbon (CB).
The interior rear panel has the same colour as the cabinet.
Also available in choice of NCS colour or mirrored (10% surcharge per shade)
Surcharge for satin glass (SAT)

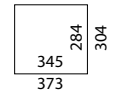

Accessories

Sound systems for technical element CO5



BRA2 virtual surround sound system

incl. Bluetooth 4.0 and HDMI interface

SCA3 sound system incl. Bluetooth 4.0 interface

COZ20 Fitting frame for sound systems
(required for SCA3 & BRA2)

Adapter for sound systems for technical element CO5



COZ22 universal adapter, max. speaker dimensions (H x D) 95 x 70 mm

COZ23 Adapter for Bose CineMate 1 SR, CineMate 130 and Bose Lifestyle 135



TV mount (T80) with integrated cable guides

For low boards with a depth of 540 mm, rotating, suitable for VESA 200 x 200 up to 400 x 400, max. load 40 kg (not available for CO2/CO2-SL/CO4 with recess for mobile devices)

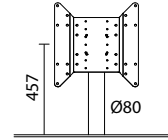

Universal Adapter SPMMOVIE VESA 100 x 100 up to 600 x 400

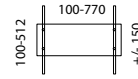

CD/DVD tray for drawers

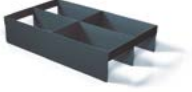

CDE6 suitable for internal drawer element COZ1
1 tray per drawer compartment possible
168 Slim-Line CDs, 84 CDs or 32 DVDs/Blu-rays per tray

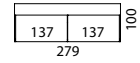
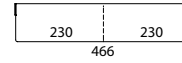

CDE8 suitable for elements CO2-SL, CO3-SL and COH1-SL
1 tray per drawer compartment possible
200 Slim-Line CDs, 100 CDs or 32 DVDs/Blu-rays per tray

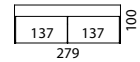
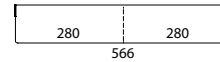

Internal drawer elements with mirrored front



COZ1 suitable for furniture elements CO2, at the bottom (max. 1 drawer) and CO3, at the bottom (max. 2 drawers)

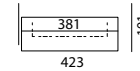
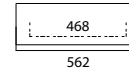

COZ4 suitable for furniture elements CO2-SL, at the top (max. 1 drawer) and CO3-SL, at the top (max. 2 drawers)

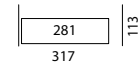
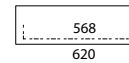

Inside rear mirror for wall cabinets with flap



COG3 Inside rear mirror for COH3 (1 pcs., 966 x 261 x 4 mm)
COG5 Inside rear mirror for COH1 (Set, 2 pcs., 623.5, 266, 4 mm)
COG6 Inside rear mirror for COH2 (Set, 2 pcs., 473 x 266 x 4 mm)

Infrared link system

For controlling your devices with closed furniture flaps



COZ11 Felt curtain for CO2, CO2-SL and CO4
COZ12 Felt curtain for CO3, CO3-SL and CO5 (Set, 2 pcs.)

Rear panel for room dividers* (coloured glass, per low board)



COR2 Rear panel room divider* for CO2, CO2-SL and CO4
Surcharge for satin glass (SAT)
COR3 Rear panel room divider for CO3, CO3-SL and CO5
Surcharge for satin glass (SAT)

Elements with room divider rear panel require a cable recess in the base (-KB, optional high-gloss or satin glass (SAT, surcharge applies)

*For models with drawers/drawer tray: only available in combination with a minimum of one CO3 or CO5, max. load per drawer compartment: 5 kg



Subwoofer opening (SP) at the bottom for CO2/CO3 incl. fabric covering

Position CO2: always centre
Position CO3: always left

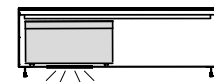



Fabric-covered flap for CO2/CO3 (STS)

In black (BF), silver (SF) or carbon (CF)
(also available as retrofit set)



Cable recess in the base (KB) for low boards with a width of 540 mm

Position: CO2, CO2-SL and CO4: always centre
CO3, CO3-SL and CO5: always right



Media player for wireless image and audio streaming

ZU1755 Apple TV for wireless music, image and video streaming



Recesses for mobile devices for low boards with a depth of 540 mm

Requires a docking kit (sold separately),

Position for low boards with a width of 1300 mm always at right, for low boards a width of 658 mm always at centre

Docking kits for Apple



ZU1876 Docking Kit 26, Apple, iPhone/iPad, HDMI (2015)

For iPhone 5/5S, iPod touch 5, iPhone 6/6 Plus,
iPad mini/mini2/mini3, iPad Air/Air2
Functions: charging, streaming music, photos and videos (HDMI)

ZU1842 Docking Kit 23, Apple, iPhone 4/4S, HDMI

For iPhone 4/4S, iPod touch 4. generations
Functions: charging, streaming music, photos and videos (HDMI)

ZU1849 Docking Kit 25, Apple, iPhone 5/5S, Audio

For iPhone 5/5S
Functions: Charging and streaming music (analogue cinch)

ZU1877 Docking Kit 27, Apple, iPad 4, HDMI (2015)

For iPad 4
Functions: charging, streaming music, photos and videos (HDMI)







Model series

BRICK

Simplify **your living room.**

UNCLUTTER YOUR LIFE WITH BRICK,
THE WORLD'S FIRST TV FURNITURE WITH SOUND IN THE BASE.

The virtual surround sound system is concealed in the unit and offers impressive home cinema entertainment with no intrusive speakers and visible cables in plain sight. Even audio and video equipment disappear in the generous space behind the brilliant and shiny glass front.





BRICK BR2001 in choice of NCS colour with mirrored base (polished stainless steel) and BRICK BR1500 with rotating TV mount

Plug in **and enjoy.**

**BRICK STANDS OUT WITH ITS RECESSED BASE THAT CREATES
THE ILLUSION OF FLOATING FURNITURE.**

Apart from the black standard base, we offer an elegant mirrored base - and as an acoustic highlight, you can choose from a range of sound bases with black fabric-covering to fit your sound systems.

Another awesome treat BRICK has in store is the iPhone and iPad docking station.

SPECTRAL docks and associated cabling are concealed within the furniture.

The mobile device is simply docked into a recess in the glass surface and stored content like music, pictures and videos are streamed directly to the television or sound system.





Sound that **makes your jaws drop.**

THE BRICK SOUND BASE OFFERS SPACE FOR DIFFERENT SOUND SYSTEMS.

Thanks to the black fabric cover, speakers
are hidden out of sight under the furniture.



Sound bases for **SPECTRAL BRA2** sound system



Sound bases for **Sonos** Playbar



Universal sound base for soundbars by a range of manufacturers



BRICK BR2001 in choice of NCS colour with mirrored base (polished stainless steel)



BRICK BR1501



BRICK BR1502 with rotating TV mount
and SPECTRAL BRA2 sound system

BRICK at a glance.

More than 2,000 colours, three different widths,
various heights and a range of combinations
of drawers and flaps – BRICK offers
the right solution for almost every requirement.

BRICK doesn't skimp on the extras:
The rotating TV mount and the CD/DVD tray insert for
drawers are tried and tested and extremely popular.

The best-seller model
of our best-seller series.



BRICK BR2000 in snow glass with glass side panel,
docking station for iPhone and iPad, outside flaps, inside drawers,
rotating TV mount (T80) with integrated cable guides

General information

Glass surfaces:	Black (BG), snow (SNG), silver (SV), choice of NCS colour (10% surcharge per shade) Choice of high-gloss or satin glass (SAT, surcharge applies)
Top panel:	Coloured glass, interchangeable
Cabinet colour inside:	Black
Front:	Coloured glass
Cabinets:	Also available with drawer instead of flap (surcharge applies)
Glass shelves:	Clear glass, adjustable spacing 32 mm
Mechanism:	Pull to open, flaps have gas springs
Load:	Top panel: max. 60 kg, glass shelves: max. 15 kg, drawers: max. 20 kg per drawer compartment
Anti-tipping device:	models with a drawer need to be mounted to the wall! (bracket included)
Other:	Magnetically secured back panels for quick cabling and good ventilation

Models with a width of 1200 mm



BR1200

Flap, 2 compartments
Surcharge for satin glass

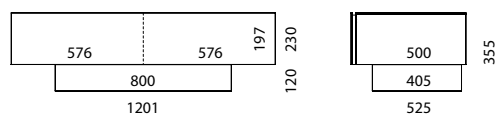

BR1201

Flap, 2 compartments
2 shelves
Surcharge for satin glass

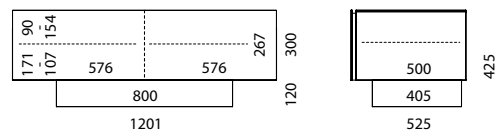

BR1202

Upper flap, 2 compartments
Lower flap, 2 compartments
Surcharge for satin glass

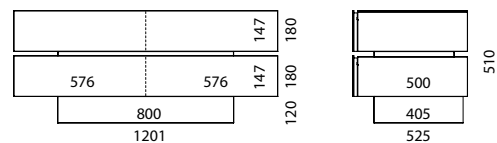

BR1202-SL

Upper flap, 2 compartments
Lower drawer, 2 compartments
Surcharge for satin glass

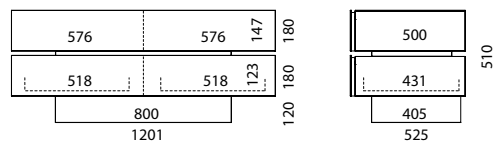

BR1203

Upper flap, 2 compartments
Lower flap, 2 compartments
Surcharge for satin glass

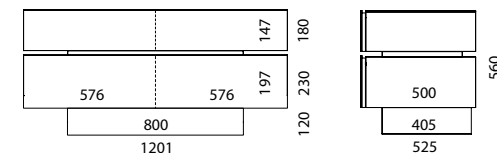

BR1203-SL

Upper flap, 2 compartments
Lower drawer, 2 compartments
Surcharge for satin glass

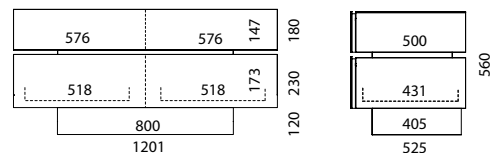

Models with a width of 1500 mm



BR1500

Flap, 3 compartments
Surcharge for satin glass

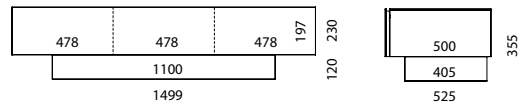

BR1501

Flap, 3 compartments
3 shelves
Surcharge for satin glass

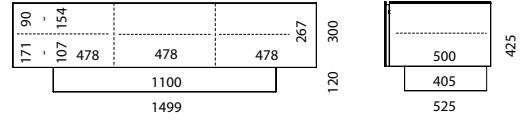

BR1502

Upper flap, 3 compartments
Lower flap, 3 compartments
Surcharge for satin glass

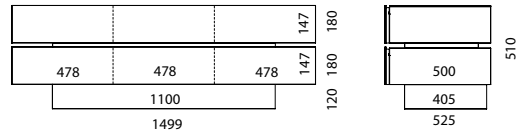

BR1502-SL

Upper flap, 3 compartments
Lower drawer, 3 compartments
Surcharge for satin glass

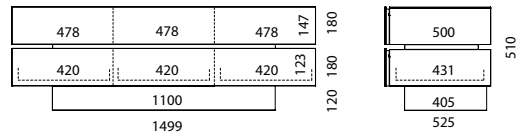

BR1503

Upper flap, 3 compartments
Lower flap, 3 compartments
Surcharge for satin glass

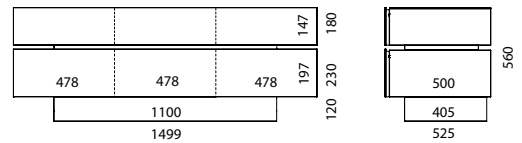

BR1503-SL

Upper flap, 3 compartments
Lower drawer, 3 compartments
Surcharge for satin glass

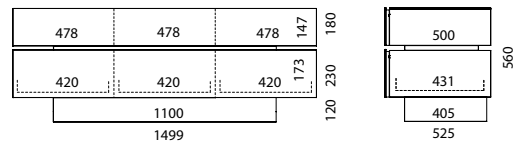

Models with a width of 2000 mm



BR2000

Left/right: flap, shelf
Lower central compartment: drawer, 2 compartments
Surcharge for satin glass

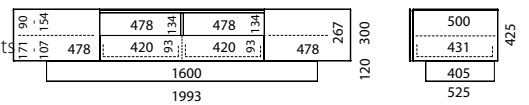

BR2001

Left/right: Flap
4 compartments, 4 shelves
Surcharge for satin glass

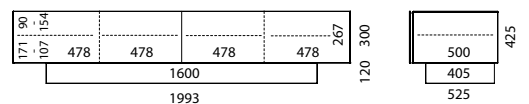

BR2001-SL

Left: flap right: drawer
4 compartments, 4 shelves
Surcharge for satin glass

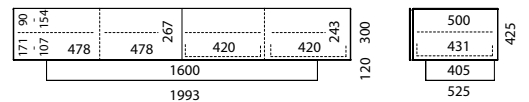

Accessories



Glass side panels (per pair)

- BRG180** for cabinets with a height of 180 mm
- BRG230** for cabinets with a height of 230 mm
- BRG300** for cabinets with a height of 300 mm



Mirrored base

- BRS10** for all models with a width of 1200 mm
- BRS11** for all models with a width of 1500 mm
- BRS12** for all models with a width of 2000 mm



Multi-coloured LED lighting

- LED835** LED element, 835 mm (1 pc), for models with a width of 1200 mm
- LED1180BR** LED element, 1180 mm (1 pc), for models with a width of 1500 mm
- LED8352** LED element, 835 mm (2 pcs), for models with a width of 2000 mm
- ZU1411** Controller set incl. remote control (required for LED lighting control)
- IR link system** required for LED lighting control



CD/DVD storage tray for drawers (cabinet height at least 230 mm)

- CDE4** for models with a width of 120 cm
480 SlimLine/240 CDs/64 DVDs/Blu-rays per tray
- CDE5** for models with a width of 150 cm or 200 cm
240 SlimLine/120 CDs/54 DVDs/Blu-rays per tray
(not suitable for centre drawers of BR2000)

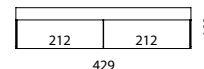
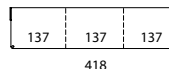
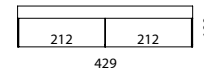
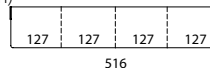

TV mount (T80) with integrated cable guides

Rotating, angle of turn 90°, maximum load 40 kg, suitable for VESA 200 x 200 up to 400 x 400

Universal Adapter SPMMOVIE VESA 100 x 100 up to 600 x 400

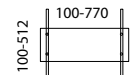

Infrared link system For controlling your devices with closed furniture flaps



BRA2 virtual surround sound system incl. Bluetooth 4.0 and HDMI interface

SCA3 sound system incl. Bluetooth 4.0 interface

Sound base for sound systems BRA2 or SCA3 (only available for BRA2 or SCA3)

BRS1-BRA or BRS1-SCA base for models with dimensions 1200 mm, 941 x 173 x 405 mm (W x H x D)

BRS2-BRA or BRS1-SCA base for models with dimensions 1500 mm, 1099 x 173 x 405 mm (W x H x D)

BRS3-BRA or BRS1-SCA base for models with dimensions 2000 mm, 1599 x 173 x 405 mm (W x H x D)

Universal sound base incl. adjustable height universal metal shelf and fabric cover in black.

Also suitable for BOSE Soundbar CineMate 1SR, CineMate 130 and Lifestyle 135 and SONOS Playbar

BRS8 base for models with a width of 1200 or 1500 mm, base dimensions: 1099 x 203 x 405 mm (W x H x D)

Max. soundbar dimensions: 1070 x 155 x 120 mm (W x H x D)

BRS9 base for models with a width of 2000 mm, base dimensions: 1599 x 203 x 405 mm (W x H x D)

Max. soundbar dimensions: 1540 x 155 x 120 mm (W x H x D)

ADSN1 Adapter for SONOS Playbar for universal sound base BRS8 or BRS9

Additional drawer Instead of a flap (standard) a drawer can also be fitted.

(Please produce a sketch and indicate the position. Anti-tipping device required)

A CD/DVD insert is available for cabinets with a minimum height of 230 mm.



Media player for wireless image and audio streaming

ZU1755 Apple TV for wireless music, image and video streaming



Recesses for mobile devices

Requires a Docking Kit (sold separately), position always at right



ZU1876 Docking Kit 26, Apple, iPhone/iPad, HDMI (2015)

For iPhone 5/5S, iPod touch 5, iPhone 6/6 Plus, iPad mini/mini2/mini3, iPad Air/Air2

Functions: charging, streaming music, photos and videos (HDMI)

ZU1842 Docking Kit 23, Apple, iPhone 4/4S, HDMI

For iPhone 4/4S, iPod touch 4. generations

Functions: charging, streaming music, photos and videos (HDMI)

ZU1849 Docking Kit 25, Apple, iPhone 5/5S, Audio

For iPhone 5/5S

Functions: Charging and streaming music (analogue cinch)

ZU1877 Docking Kit 27, Apple, iPad 4, HDMI (2015)

For iPad 4

Functions: charging, streaming music, photos and videos (HDMI)

Model series

DISC



Stay sophisticated.

YOU LOVE CLASSICAL FURNITURE, BUT HAVE DISCOVERED THE JOYS OF
STATE-OF-THE-ART HOME CINEMA-TECHNOLOGY?

Puristic DISC by SPECTRAL combines classic and modern design in one piece of furniture:
The levitating unit atop a robust glass base offers space for a variety of sound systems
and auxiliary equipment. DISC is also available with a docking station for mobile devices.



Pure enjoyment on all fronts.

You choose whether you want to use your DISC with or without integrated sound and then select a fabric or glass front.

The fabric front is available in black, silver and carbon.

The glass front comes in the furniture colour, and is thus also available in over 2,000 colours.



Disc DS06 in NCS colour (dark blue) with rotating TV mount and docking station for iPhone and iPad



Disc DS07 in NCS colour (coral) with rotating TV mount and docking station for iPhone and iPad



Disc DS51 in NCS colour (grey) with fabric-covered flap in silver (SF), rotating TV mount and docking station for iPhone and iPad

Home of sweet music.

DISC offers a range of solutions for integrating sound.

The models DISC DS51 and DS81 have been optimised for use with BRA2 and SCA3 sound systems by SPECTRAL.

The model DISC DS01 offers space for a range of soundbar systems by various manufacturers.

DISC DS81 in snow glass with fabric flap in silver with SPECTRAL sound system BRA2, docking station for iPhone and iPad and rotating TV mount



Disc DS01 is the universal solution for a wide range of soundbar systems with subwoofers.

What's more, there is even enough space for 2 devices. The universal adapted included is compatible with soundbars that have a maximum size of (W x H x D): 1300 x 145 x 80 mm.

DISC DS01 in snow glass with fabric flap in silver, docking station for iPhone and iPad, rotating TV mount and Samsung sound system.

**Models DISC DS03 and DS04
are the new home of Bose
home cinema systems CineMate 1SR,
CineMate 130 and Lifestyle 135.**

A recess in the upper edge of the furniture provides room for the Bose speaker arrays. Additional space for the associated Acoustimass module can be found behind the fabric-covered flap of the DS04 - for impressive deep base sounds without subwoofers in plain sight.



DISC DS03 in snow glass with flap, for Bose speaker arrays, docking station for iPhone and iPad, rotating TV mount



Disc DS04 in snow glass with fabric flap in silver for Bose speaker arrays and Acoustimass module, docking station for iPhone and iPad, rotating TV mount

General information

Glass surfaces:	Black (BG), snow (SNG), silver (SV), choice of NCS colour (10% surcharge per shade)
Top panel:	Coloured glass, interchangeable, cable recess as standard (always in centre)
Base panel:	Cable recess as standard
Cabinet colour inside:	Black
Fabric front:	Choice of black (BF), silver (SF) or carbon (CF)
Glass shelves:	Clear glass, adjustable spacing 32 mm
Glass side panel:	Glass side panels on exterior as standard (LR)
Base:	In clear glass (KG) or black glass (BG), column in aluminium
Mechanism:	push to open
Subwoofer opening:	Incl. fabric cover
Load:	DS01, DS51, DS06: Total load max. 30 kg, top panel max: 30 kg, outer compartments (left/right) max. 8.5 kg per compartment DS03, DS04, DS07, DS81: total load max. 30 kg, top panel max: 30 kg, glass shelves: max. 15 kg
Other:	Sound systems are not included in delivery

Models



DS07
Flap (glass front), 2 compartments, 2 shelves

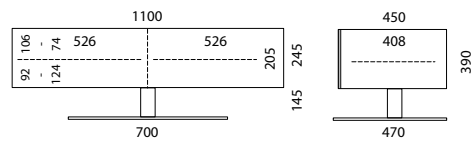

DS81
Suitable for SPECTRAL sound systems BRA2 and SCA3
Fabric-covered flap, 2 upper compartments for devices,
1 lower compartment for sound systems (only available for
BRA2 or SCA3)

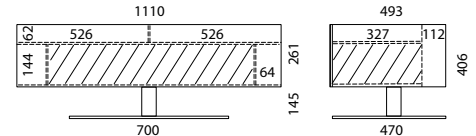

DS06
Flap (glass front), 3 compartments, 3 shelves

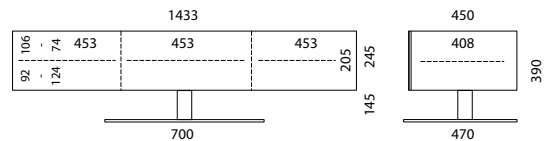

DS01
Suitable for many soundbar systems and subwoofers
(with subwoofer placement inside the furniture)
Fabric-covered flap, subwoofer opening
incl. universal metal shelf for soundbars
Max. soundbar dimensions: 1300 x 145 x 80 mm (W x H x D)
Max. subwoofer dimensions: 400 x 190 x 300 mm (W x H x D)

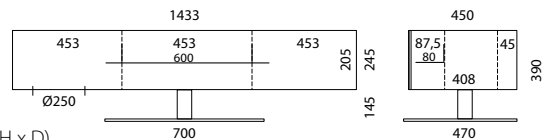

DS51
Suitable for SPECTRAL sound systems BRA2 and SCA3
Fabric-covered flap, 3 upper compartments for devices,
3 lower compartments (1 compartment for sound systems,
only available for BRA2 or SCA3)

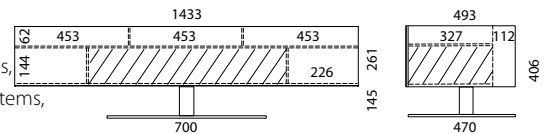

DS03
Suitable for Bose CineMate 1SR, CineMate 130 and Lifestyle 135
(without subwoofer placement inside the furniture)
Flap (glass front) and shelf for Bose sound projector

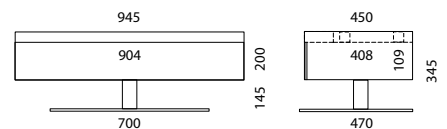

DS04
Suitable for Bose CineMate 1SR, CineMate 130 and Lifestyle 135
(with subwoofer placement inside the furniture)
Fabric-covered flap and shelf
for Bose sound projector

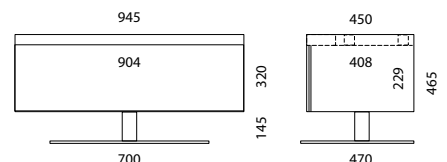

Accessories



Sound systems

BRA2 virtual surround sound system incl. infrared remote control

SCA3 sound system incl. infrared remote control



ADB02

Suitable for Bose CineMate 1SR, CineMate 130 and Lifestyle 135



TV mount (TX)

Rotating, suitable for VESA 200 x 200 up to 400 x 400

maximum load 40 kg, position: centre

Universal adapter SPMMOVIE

VESA 100 x 100 up to 600 x 400

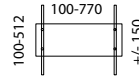

Infrared link system

For controlling your devices with closed furniture flaps



Rear panel for room dividers (coloured glass)

DSR1 for DS81

DSR2 for DS51

ZU1868 TV cover 934 x 560

For elements with TV mount TX

suitable for many TV models from 46" with VESA 400 x 400

coloured high-gloss glass

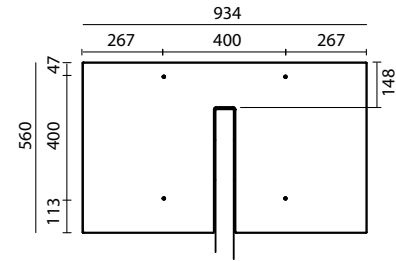

Cover for cable recess in the top panel

ZU1803 Cable recess cover in silver

ZU1804 Cable recess cover in black



Media player for wireless image and audio streaming

ZU1755 Apple TV for wireless music, image and video streaming



Recesses for mobile devices

Requires a Docking Kit (sold separately), position always at right

Apple Docking Kits

ZU1876 Docking Kit 26, Apple, iPhone/iPad, HDMI (2015)

For iPhone 5/5S, iPod touch 5, iPhone 6/6 Plus,

iPad mini/mini2/mini3, iPad Air/Air2

Functions: charging, streaming music, photos and videos (HDMI)

ZU1842 Docking Kit 23, Apple, iPhone 4/4S, HDMI

For iPhone 4/4S, iPod touch 4. generations

Functions: charging, streaming music, photos and videos (HDMI)

ZU1849 Docking Kit 25, Apple, iPhone 5/5S, Audio

For iPhone 5/5S

Functions: Charging and streaming music (analogue cinch)

ZU1877 Docking Kit 27, Apple, iPad 4, HDMI (2015)

For iPad 4

Functions: charging, streaming music, photos and videos (HDMI)



Music below.
Cabinet on top.



SPECTRAL MUSIC BOX SMB1-iP
with flap - for additional devices such as a CD player or WIFI router



SPECTRAL MUSIC BOX SMB2-iP
with drawer - the ideal place for storing all sorts of odds and ends



Model series

MUSIC BOX

THE PERFECT COMBINATION OF FURNITURE AND SOUNDDOCK.

Once its placed in the station, your mobile device unleashes excellent sound from the integrated SCA3 sound system, providing the musical backdrop for relaxation after hours. It gets charged up while in action and starts the next day perfectly fit for phone calls and surfing.



Simply **expandable.**

For your living room, lounge or reading corner - the SPECTRAL MUSIC BOX is a perfect combination for your SCALA and COCOON wall cabinets. The SCH37 open wall cabinet creates additional storage area for books, magazines and other nice things, for example.



Open wall cabinet (SCH37)



The cabinet comes with a matt coating in black (SW), white (WS) or carbon (CB). The interior rear panel is made of glass and coated in the same colour as the cabinet. The glass panel is also available in choice of NCS colour or mirrored. The glass panel is interchangeable and is an inexpensive option for changing colours to suit your needs and brighten up your room.

General information

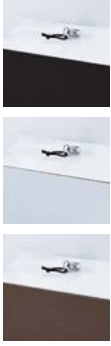

Glass surfaces:	Black (BG), snow (SNG), silver (SV), choice of NCS colour (10% surcharge per shade), choice of high-gloss or satin glass (SAT, surcharge applies)
Cabinet colour inside:	black
Top panel:	Coloured glass, interchangeable top panel with cable recess at the rear edge (left)
Fabric front:	Choice of black (BF), silver (SF) or carbon (CF)
Glass side panels:	If several elements are combined, the position of the glass side panels must be indicated (L for left, R for right, LR for left and right). Glass side panels are not available for SCH37.
Rear panel	Cable recess as standard
Mechanism:	Push
Load:	SMB1: Total load max. 45 kg, glass top max. 20 kg SMB2: Total load max. 45 kg, glass top max. 5 kg, drawer max. 20 kg SCH37: Total load max. 10 kg
Other:	Sound systems and docks are not included in delivery

Models



SMB1-iP SMB1

with recess for mobile devices
without recess for mobile devices
1 continuous fabric-covered flap,
2 upper compartments for devices,
1 lower compartment (suitable for sound system SCA3)

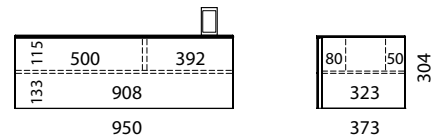

SMB2-iP SMB2

with recess for mobile devices
without recess for mobile devices
1 upper drawer with glass front,
1 lower fabric-covered compartment
(suitable or SCA3 sound system)
incl. 3-socket strip

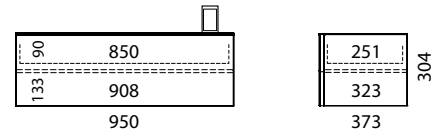

SCH37

open wall cabinet, 373 mm deep,
interior rear panel in glass
also available in choice of NCS colour or mirrored
(10% surcharge per shade)

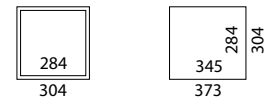

Accessories



SCA3

SCA3 sound system

incl. Bluetooth 4.0 interface for wireless music streaming



ZU1876

Docking Kit 26, Apple, iPhone/iPad, HDMI (2015)

For iPhone 5/5S, iPod touch 5, iPhone 6/6 Plus,
iPad mini/mini2/mini3, iPad Air/Air2
Functions: charging, streaming music, photos and videos (HDMI)

ZU1842

Docking Kit 23, Apple, iPhone 4/4S, HDMI

For iPhone 4/4S, iPod touch 4. generations
Functions: charging, streaming music, photos and videos (HDMI)

ZU1849

Docking Kit 25, Apple, iPhone 5/5S, Audio

For iPhone 5/5S
Functions: Charging and streaming music (analogue cinch)

ZU1877

Docking Kit 27, Apple, iPad 4, HDMI (2015)

For iPad 4
Functions: charging, streaming music, photos and videos (HDMI)

Model series

COCKPIT

Dock the table.

COCKPIT is the elegant side table by SPECTRAL. A classy charging station for your iPhone or iPad, and the new control centre in your living room.

At the press of a button, you can stream music, photos, videos or internet content to your TV or sound system from the comfort of your sofa.



COCKPIT CP30 in snow glass with fabric-covered door
in silver and docking station for iPhone and iPad



COCKPIT CP20 in snow glass
with docking station for iPhone and iPad

General information

Glass surfaces:	Black (BG), snow (SNG), silver (SV), choice of NCS colour (10% surcharge per shade)
Cabinet colour:	Black
Top panel:	Coloured glass
Glass side panel:	Glass side panels on exterior (LR) as standard
Fabric front:	CP30 hinged door: Black (BF), silver (SF) and carbon (CF)
Base:	CP20: Steel plate with affixed coloured glass panel (same glass colour as top panel) + aluminium pipe (D=30 mm), CP30: aluminium base

Models



CP20

drawers, push to open
Glass top panel magnetically attached
concealed cabling through the base
optional recess for mobile devices,
rotating in four directions

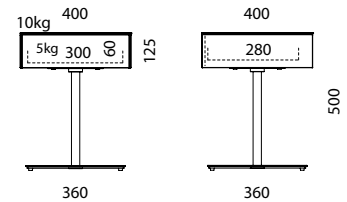

CP30

fabric-covered hinged door, push to open
Glass top panel magnetically attached
Subwoofer recess and cable recess in base
Glass shelf with adjustable height
Suitable for various subwoofers
(e.g. by Samsung, Bose, Loewe, ...)
Max. size of subwoofer:
375 x 400 x 390 mm (W x H x D)
Optional recess for mobile devices,
rotating in four directions

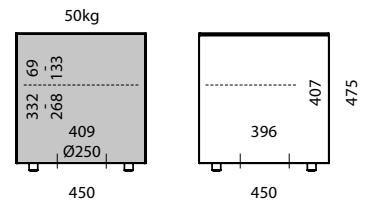

Docks



ZU1876

Docking Kit 26, Apple, iPhone/iPad, HDMI (2015)

For iPhone 5/5S, iPod touch 5, iPhone 6/6 Plus,
iPad mini/mini2/mini3, iPad Air/Air2
Functions: charging, streaming music, photos and videos (HDMI)

ZU1842

Docking Kit 23, Apple, iPhone 4/4S, HDMI

For iPhone 4/4S, iPod touch 4. generations
Functions: charging, streaming music, photos and videos (HDMI)

ZU1849

Docking Kit 25, Apple, iPhone 5/5S, Audio

For iPhone 5/5S
Functions: Charging and streaming music (analogue cinch)

ZU1877

Docking Kit 27, Apple, iPad 4, HDMI (2015)

For iPad 4
Functions: charging, streaming music, photos and videos (HDMI)

Model series

TRAY



PX601SX-SNG with SONOS Playbar

TRAY IS OUR ELEGANT TV STAND WITH SCRATCH-RESISTANT GLASS SURFACE IN OVER 2,000 COLOURS

Thanks to the compact design, TRAY is the perfect solution for your bedroom, meeting rooms and hotel suites that have no room for bulky TV tables. Its double wheels allow flexible placement in the room. A universal mount ensures that all sorts of TVs feel right at home with TRAY. All cables disappear into a chic and easily-accessible cable guides at the back.



Integrated cable runs with outlets at front and back.
Removable rear panel for simple and elegant connection of cables



General information

Glass colours: Snow (SNG), silver (SV), black (BG) choice of NCS colour (10% surcharge)
 Base: Wooden base with wheels and glass top (max. load: 20 kg), column and metal parts in black
 Max. load of TV mount: 40 kg, max. load of glass shelf: 10 kg, Cable guide recess: Ø 50 mm

Models with glass shelf

Models without glass shelf

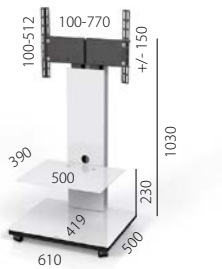

PX601
PX601SX

(sound prepared version
with connection for adapter)

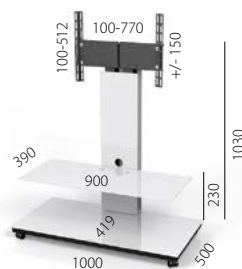

PX701
PX701SX

(sound prepared version
with connection for adapter)

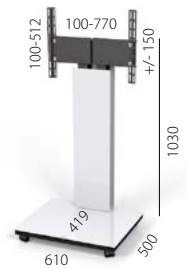

PX600
PX600SX

(sound prepared version
with connection for adapter)

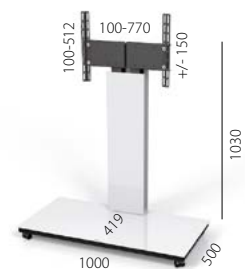

PX700
PX700SX

(sound prepared version
with connection for adapter)

Accessories

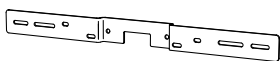

ADS2

Adapter for Samsung soundbars
HW-F450 / HW-F550
HW-H355 / HW-H450 / HW-H750

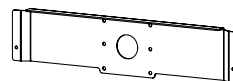

ADB04

Adapter for BOSE soundbar
CineMate 1SR, CineMate130,
Lifestyle 135

Registered trademarks of Bose.

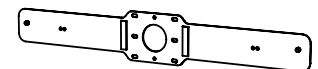

ADSN1

Adapter for SONOS Playbar

Heavy Metal for the eyes.

PROUDLY SHOW OFF YOUR SOPHISTICATED AUDIO EQUIPMENT -
WITH OUR IMPRESSIVE HIGH-END HI-FI FURNITURE.

This heavy-weight is fitted with particularly massive aluminium columns and extra-thick 19 mm glass panels. Hanging cables can be bundled with an optional cable channel.



HE684-BG+SK+KK



Model series

HIGH-END

General information

Glass colours: Clear (KG), Black (BG), Matte (MG)

Tube colour: Aluminium (AL)

Max. load per glass shelf: 40 kg (HSL) and 60 kg (HE)

Models with 80 mm x 80 mm aluminium tubes and 19 mm glass plates (HE)



HE682

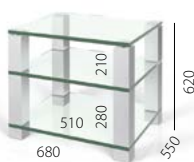

HE683



HE684



HE1203

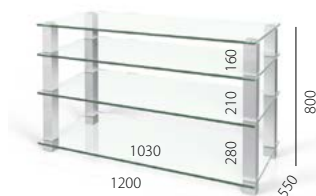

HE1204

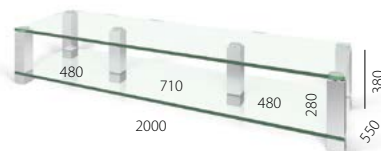

HE2002

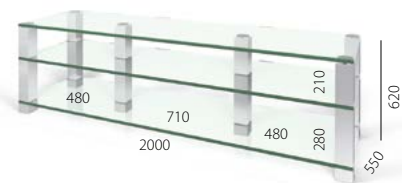

HE2003

Models with 60 mm x 60 mm aluminium tubes and 12 mm glass plates (HSL)



HSL613



HSL614



HSL1203

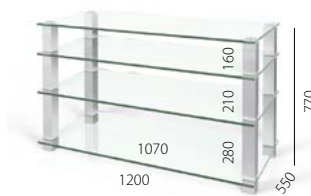

HSL1204

Accessories

Cable channel (for models with 2, 3 or 4 glass levels)



HEKK2
HEKK3
HEKK4

HSLKK2
HSLKK3
HSLKK4

Spikes



HESP (4-pcs. set)
HESP2 (6pcs. set)
HSLSP (4-pcs. set)

Wheels



(for HSL models, 4-pcs. set)
ZU1588

Glass/metal models

CLASSICS



PL MODELS

Glass colours: Clear (KG), Black (BG), Matte (MG)

Tube colour: Aluminium (AL)

Max. load per glass shelf: 40 kg (except PL60)

Max. load of TV mount: 40 kg

Max. load of glass shelf (PL60): 10 kg

Max. load of glass base (PL60): 20 kg



PL60

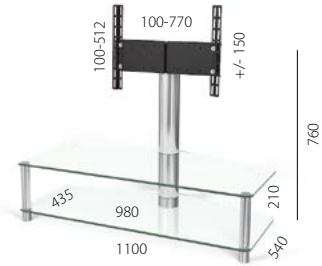

PL151



PL152

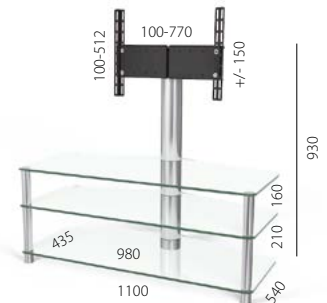

PL181

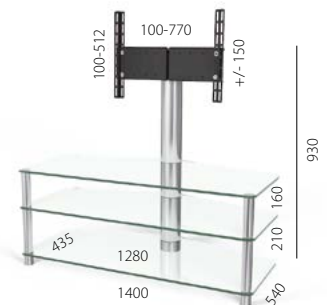

PL182



QX1011-KG



QX203-BG



QX200



QX203



QX1000

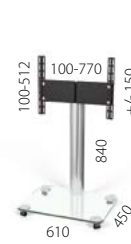

QX1001

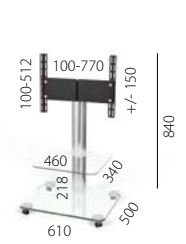

QX1011

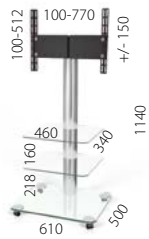

QX1010

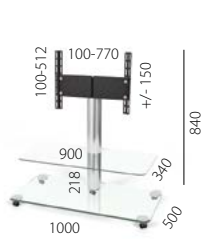

QX1211

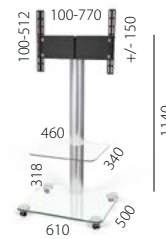

QX1012

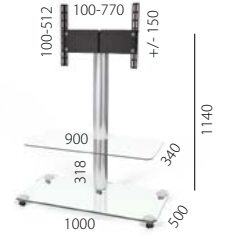

QX1212

QX MODELS

Glass colours: Clear (KG), Black (BG), Matte (MG)

Tube colour: Aluminium (AL)

Body colour (QX208, QX111): Black metallic (SM)

All models incl. rotating TV mount with 90° rotation

and integrated cable guides (QX200, QX203, QX208: incl. VESA 200 and VESA 400 Adapter)

Total load max: 40 kg (QX200, QX203, QX208: 30 kg)

Max. load of TV mount: 40 kg (QX200, QX203, QX208: 30 kg)

Max. load of glass shelf 10 kg

Max. load of glass shelf 20 kg

Max. load per body compartment (QX208, QX111: 10 kg)

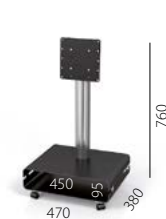

QX208

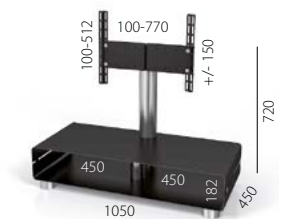

QX111

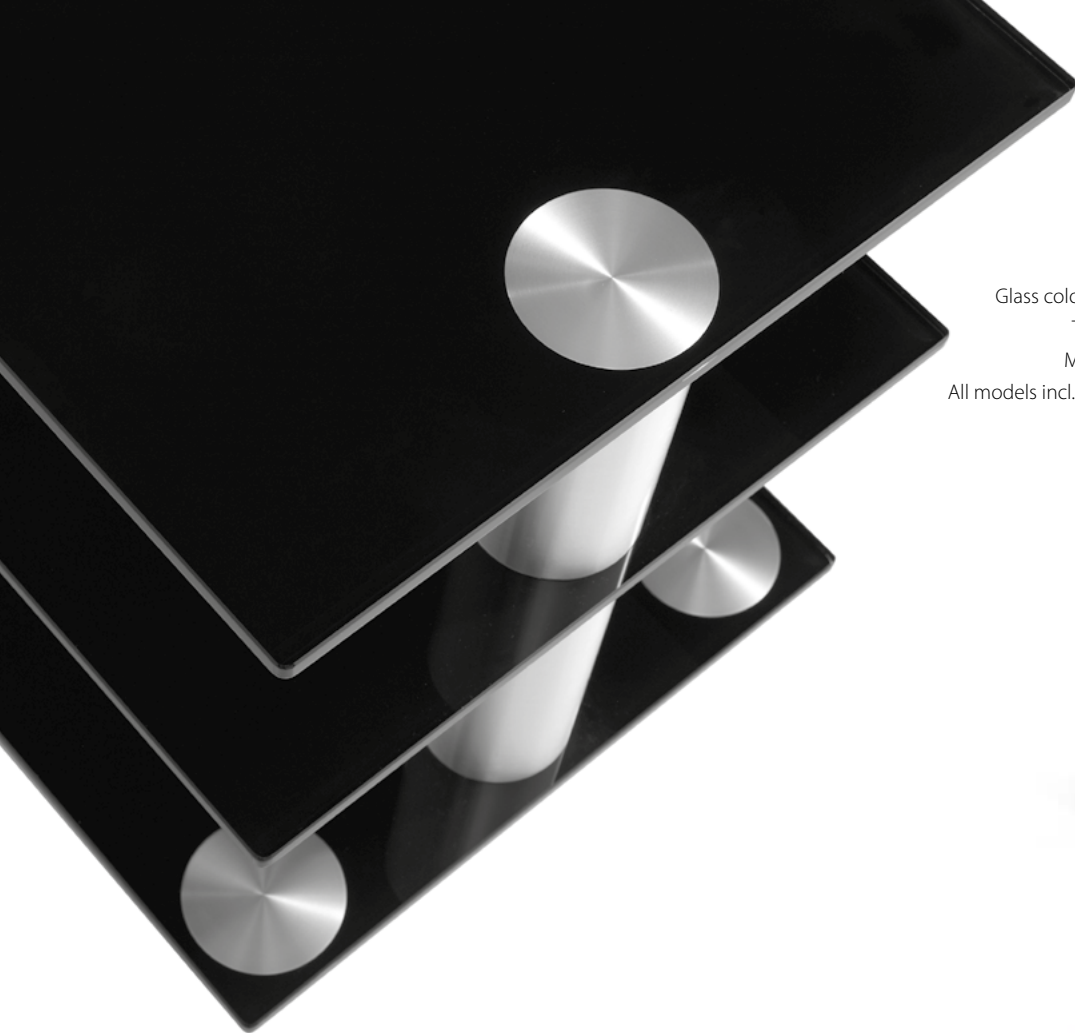

S MODELS

Glass colours: Clear (KG), Black (BG), Matte (MG)

Tube colour: Aluminium (AL)

Max. load per glass shelf: 40 kg

All models incl. cable channel and invisible double wheels



S93



S103



S133



S143



S103-BG

CL MODELS

Glass top colours: Clear (KG), matte (MG), black (BG), snow (SNG), silver (SV), choice of NCS colour (10% surcharge per shade)

Front colours: Black (BG), snow (SNG), silver (SV), aluminium (AL), choice of NCS colours (10% surcharge), Cabinet colour: Black

Optional: Drawer (SL) instead of flap and CD/DVD insert CDE4 for 480 Slim-Line CDs, 240 CDs or 64 DVDs/Blu-rays per tray

Max. load of top panel (CL340, CL342): 40 kg

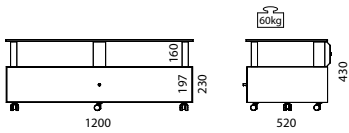
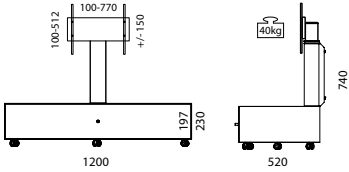
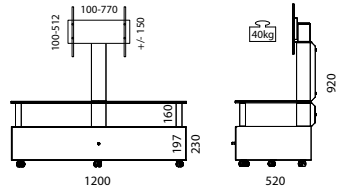

CL342

with rotating TV mount and integrated cable guides



CL340

in choice of NCS colour



CL341

in black glass with top panel in black glass

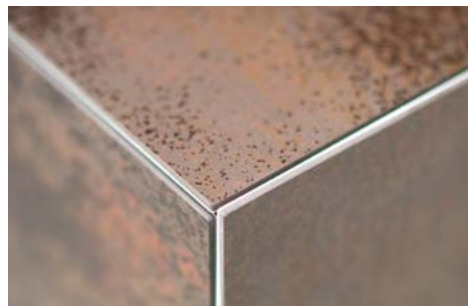



Model series

AMENO



AMENO – THE HIGHLIGHT BY SPECTRAL

Interior design and top range home entertainment blend into one with AMENO by Spectral. The furniture series can be planned in every detail and captivates with outstanding technical solutions and an exclusive material mix of glass, wood veneer, aluminium and ceramic.

Please see our AMENO catalogue or visit a selected specialist retailer to find out all the option AMENO has to offer.

Model series

CATENA



ANYTHING PLANNED FOR TODAY?

CATENA is the individually tailored home cinema and lounge furniture range by SPECTRAL.

With cabinets in various widths, heights and depths. With flaps, doors or drawers.

With high-quality sofa upholstery for lounge areas. With a great range of mounting solutions for flat-screen TVs. And with integrated virtual surround sound system for authentic, concert-like sound – without visible cables, speakers, subwoofers or receivers in plain sight.

CATENA is available from authorised CATENA partners.



With the CATENA planning guide, you can design your own CATENA step-by-step. Please visit www.spectral.eu to download the brochure or pick it up from an authorised CATENA partner near you. They can even help you configure your furniture on a computer, using the CATENA 3D planning software.



Original

ACCESSORIES



SPECTRAL SPRAY

Soft foam cleaner for LED LCD, plasma and computer screens. Also suitable for glass, metal and varnished surfaces. With anti-static microfibre cloth for quick and streak-free cleaning (content 300 ml).



SPECTRAL CLEAN

Anti-static microfibre cloth for cleaning of sensitive glass and plastic surfaces **without chemical additives**. Ideal for laptops, flat-screens, tablets, cameras, smartphones. With carbon honeycomb structure.



TV WALL MOUNTS

Sophisticated wall mounts for your TV in any size and functionality – fixed to the wall, tilt and swivel or telescopic tilt and swivel.



INTERIOR LIGHTING ZU1873

LED luminaire with motion sensor, re-chargeable via mini USB (charger ZU1874), available as retrofit option.



INFRARED LINK SYSTEM

For controlling your devices with closed furniture flaps.



APPLE TV ZU1755

Media player for wireless music, image and video streaming.

SPEAKER STANDS

Sophisticated speaker stands with integrated cable guides. Columns in polished aluminium.

Foot in safety glass. Available in clear glass, black glass and matte glass (delivered as pairs).



SP1, height: 850 mm
Speaker stands for SONOS Play 1
SP1BG: Foot in black glass
SP1SV: Foot in silver glass



LS600
Sophisticated and stable speaker stands that meet the highest audiophile demands, incl. height-adjustable spikes
Height: 600mm. Max. load: 20 kg
Shelf: 170 x 280 mm



DS90, height: 850 mm
Speaker stands for small satellite speakers
Max. load: 2 kg



DS85, height: 850 mm
Speaker stands for medium-sized satellite speakers
Max. load: 5kg



BS70, height: 700 mm
Shelf: 150 x 170 mm
BS58, height: 580 mm
Shelf: 150 x 170 mm
BS40, height: 400 mm
Shelf: 200 x 200 mm
Speaker stands for compact speakers
Max. load: 10 kg

it's
a smart
world!

Simply plug and play

DOCKS

ZU1876 DOCKING KIT 26, Apple, iPhone/iPad, HDMI (2015)

For iPhone 5/5S, iPod touch 5, iPhone 6/6 Plus,
iPad mini/mini2/mini3, iPad Air/Air2
Functions: charging, streaming music, photos and videos (HDMI)

ZU1842 DOCKING KIT 23, Apple, iPhone 4/4S, HDMI

For iPhone 4/4S, iPod touch 4. generations
Functions: charging, streaming music, photos and videos (HDMI)

ZU1849 DOCKING KIT 25, Apple, iPhone 5/5S, Audio

For iPhone 5/5S
Functions: Charging and streaming music (analogue cinch)

ZU1877 DOCKING KIT 27, Apple, iPad 4, HDMI (2015)

For iPad 4
Functions: charging, streaming music, photos and videos (HDMI)



For further information about the kits and solutions
please visit spectral.eu/de/dockfinder



SOUND SYSTEMS

VIRTUAL SURROUND SOUND WORK?

SOUND COMPLICATED?

NO, SOUNDS FANTASTIC.

The left and speakers, as well as the subwoofers (2.1), are integrated in one loudspeaker unit. With the help of advanced sound processing, your ear perceives a surround effect without the need to install five speakers and a subwoofer (5.1) as with a traditional surround system. With DTS® Tru-Surround-Technology, you no longer need walls or other reflective surfaces.

All new Spectral sound systems come equipped with an IR programmable feature. You no longer need additional remote controls or complicated universal remote controls, you can now control your sound system with your regular TV remote control.

ADVANTAGES

- ✓ No loudspeakers scattered about
- ✓ No visible cables lying about
- ✓ Integrated Bluetooth 4.0 interface for wireless music streaming
- ✓ Integrated subwoofers and amplifier
- ✓ Controlled via your regular TV remote
- ✓ Allows any sound positioning within the room
- ✓ Ultra low heat generation thanks to the digital amplifier
- ✓ Components that match and complement each other perfectly
- ✓ BRA2 and VRA2 also with additional HDMI interface

THE XTA1 SOUND SYSTEM

Wide, black, strong. Less than 7 cm high, the sensationally flat 2.1 virtual surround system XTA1 scores with its unbelievable sonorous bass. Depth you can hear, not see. Yet, the system can do more than surround mode; it equally stands out in stereo mode. And the option to play music directly from your smartphone via Bluetooth is extremely practical.

THE SCA3 sound system

Completely blown away by the sound that the SCA3 produces, we double-checked for safety's sake if there really were no other speakers or subwoofers running. Even in terms of performance, the "little" sound system showed impressive results in our big test room. Great effects, clearly understandable dialogues and a bass you can actually feel, we truly enjoyed how it played "Skyfall".

THE SOUND SYSTEM BRA2

Our best-seller Enormously strong and stable surround sound system volume level that can be adjusted to acoustically difficult spaces, thanks to an advanced signal processor. For those who really want a home entertainment system from a one-box solution in the living room, the BRA2 is the best alternative.

THE SOUND SYSTEM VRA2

Uncompromising stereo and surround sound performance. The sound is captivating lively and harmonious. Bass and base tones work hand in hand to offer a fantastic sound experience. Put simply: the best front surround system money can buy.



Quality **you can touch.**

Made in Germany

SOPHISTICATED AND ROBUST

We use only the best materials, fittings and dampers.
All connecting elements are made from solid aluminium.

The stainless steel used receives a high gloss polish,
aluminium is polished and sealed.



SCRATCH-RESISTANT AND DURABLE

The coloured glass surfaces by SPECTRAL
are brilliant, scratch-resistant and easy-care.





SPECTRAL SHOWROOMS

Visit our showrooms in Germany and the Netherlands and experience Spectral in its purest form.

Current visiting hours can be found at www.spectral.eu



MADE IN GERMANY

While more and more furniture manufacturers are moving production to the Far East, at SPECTRAL, we're remaining faithful to our roots. With our plant in Pleidelsheim near Stuttgart, we have made a clear commitment to Germany as production location. A decision that benefits our staff as much as our customers. This is only in this way we can maintain our high quality standards in the future and realise your individual requests.

COLOURS

GLASS SURFACES:

You can choose from the three standard colours silver (SV), snow (SNG) and black (BG), as well as over 2,000 NCS colours with the help of a colour fan. You can order a binding glass colour sample from the SPECTRAL online shop or an authorised dealer. The price of the glass colour sample will then be credited towards your furniture purchase.



SATIN GLASS

Cocoon, Scala, BRICK and the MUSIC BOX are also available in satin glass. It gives your furniture a matte, elegant look.



Natural variances:

Glass is produced from natural raw materials and is subject to production-related fluctuations. Colour shades can vary based on the natural colour and the thickness of the glass, as well as the lighting conditions. As a result of the production process, the colour delivered may slightly differ from the sample. Batch-based colour deviations are possible for subsequent deliveries of glass surfaces.



GLASS SURFACE IN OVER 2,000 NCS COLOURS



COLOURS FOR FABRIC FRONTS

The covers of the fabric flaps and sound covers are available in colours:

Black (BF), silver (SF) and carbon (CF)

The sound cover for BRICK is only available in black (BF).

Thank you!

Photography: Peter Oppenländer and Steffen Jahn

Models: Alex and Angi

Print: Göhring Druck



Technical changes, differences in colour due to printing and errors excepted

Nominal charge: €5

2nd edition

SPECTRAL Audio Möbel GmbH

Robert-Bosch-Str. 1-5, 74385 Pleidelsheim, Germany

Telephone: +49 (0)7144 88418-80, Fax: +49 (0)7144 88418-40

Email: info@spectral.eu

■ **SPECTRAL**
Smart furniture

N° 2 2015